

# DIS after HERA? The LHeC Project

Paul Newman  
(University of Birmingham)  
IPPP Seminar  
20 November 2008

- Where HERA leaves us
- Physics case for high luminosity TeV Scale DIS
- First Physics studies
- Accelerator & Detector

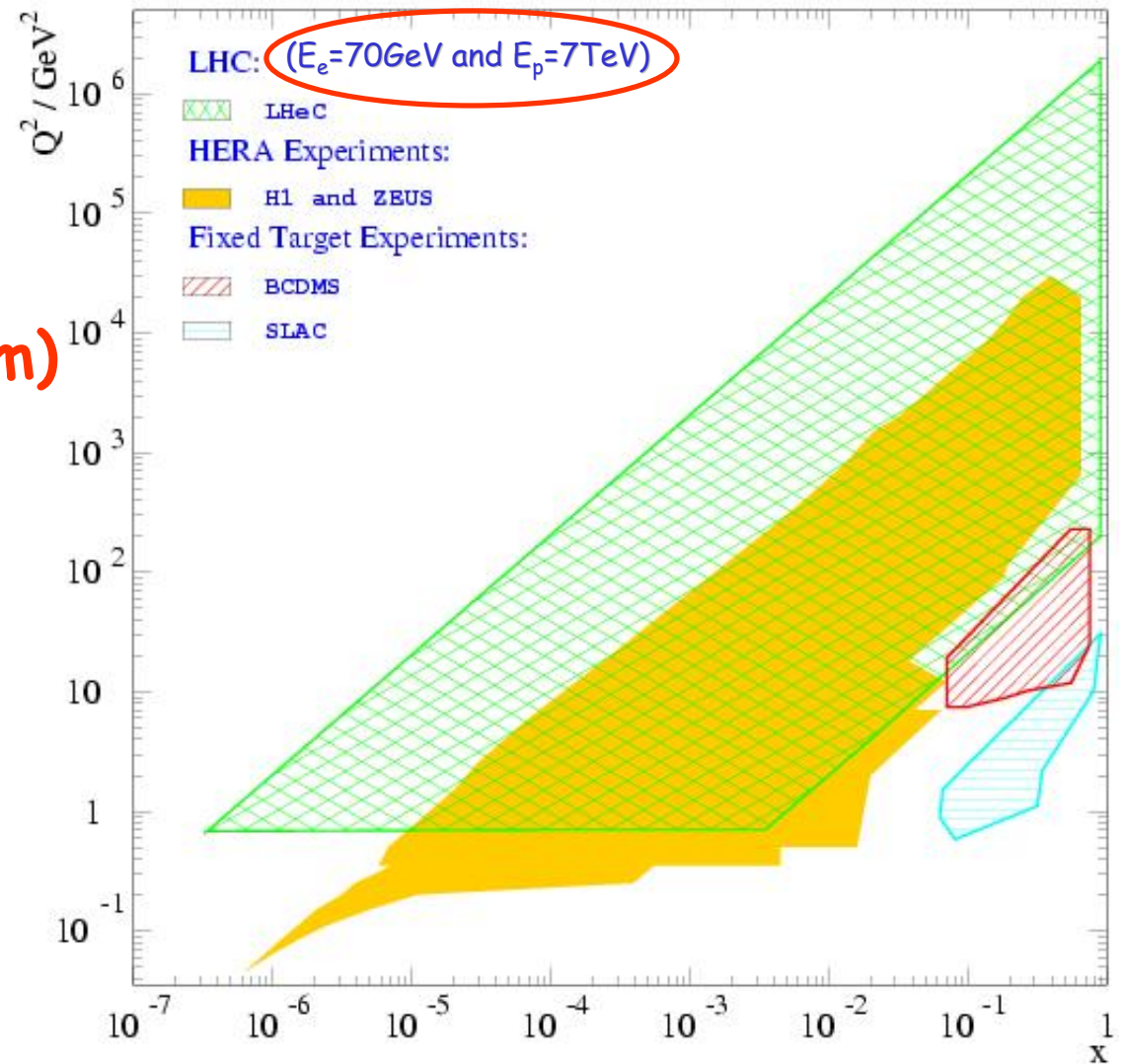

<http://www.lhec.org.uk>

# Collage of "Text-Book" HERA Plots

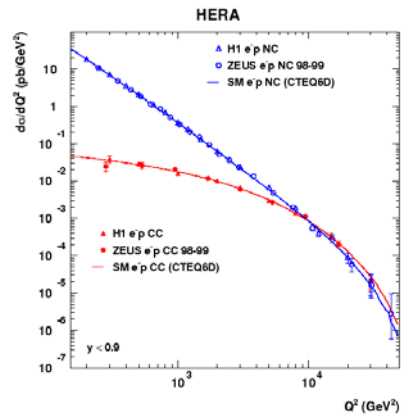
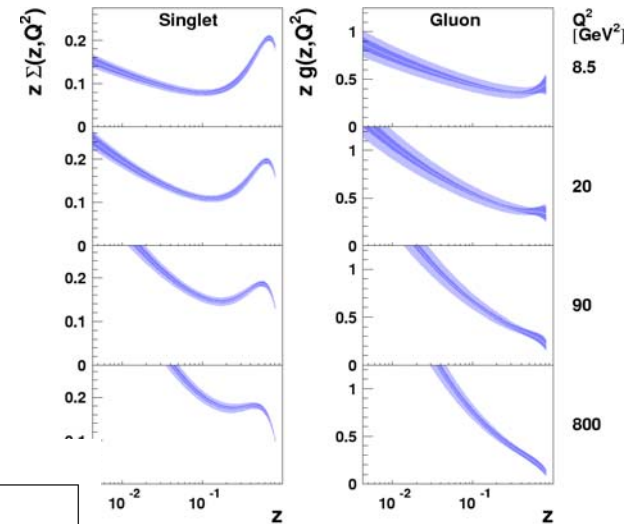
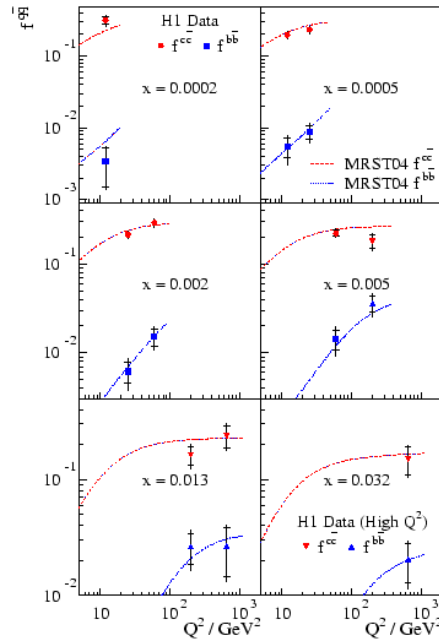
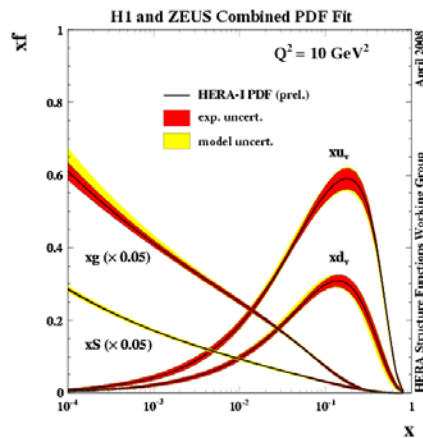
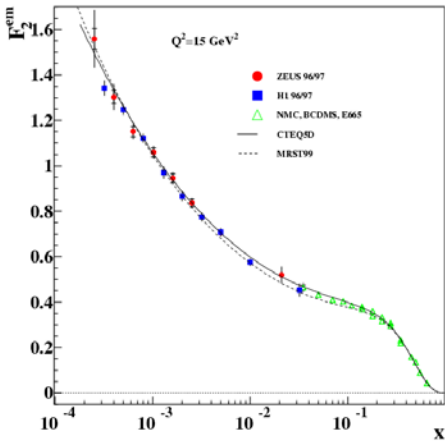
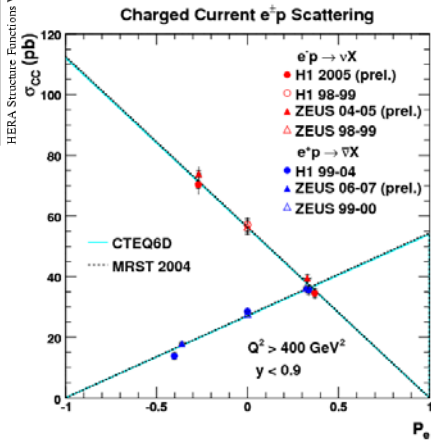
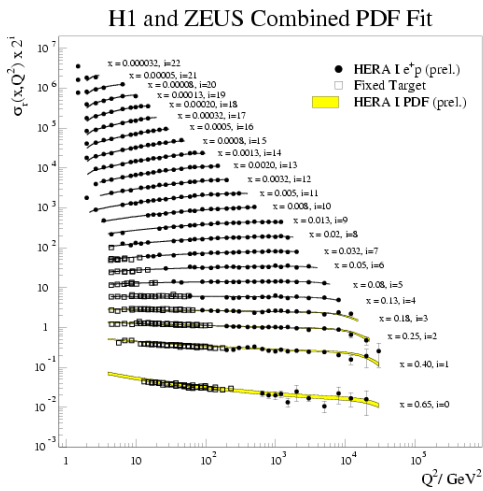

H1 2006 DPDF Fit A (exp. error) (exp.+theor. error)

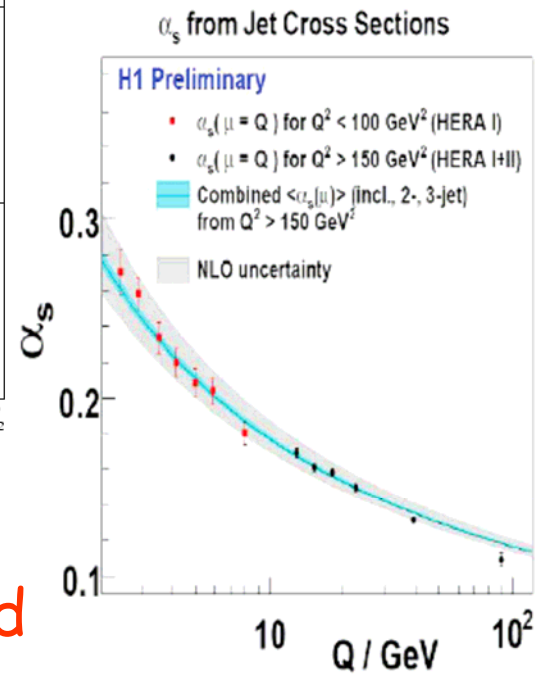

Further progress often limited by energy and luminosity ...

# Is HERA finished?

... perhaps yes for searches

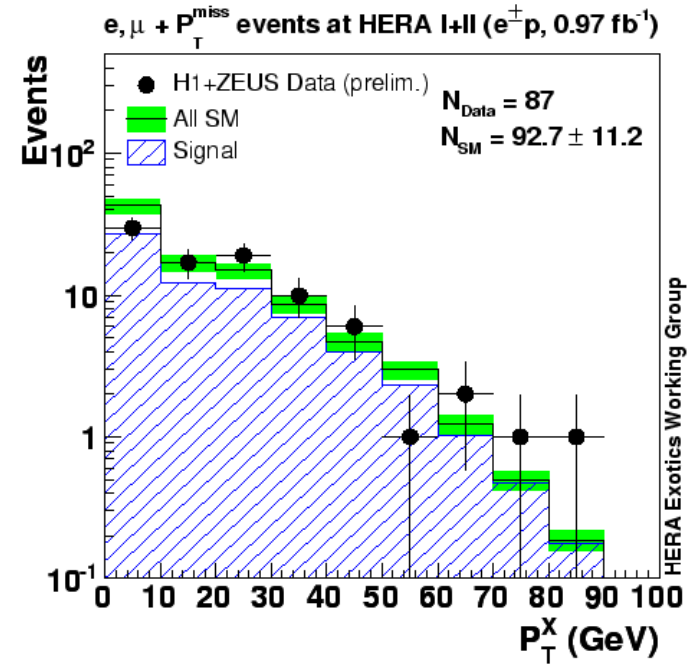
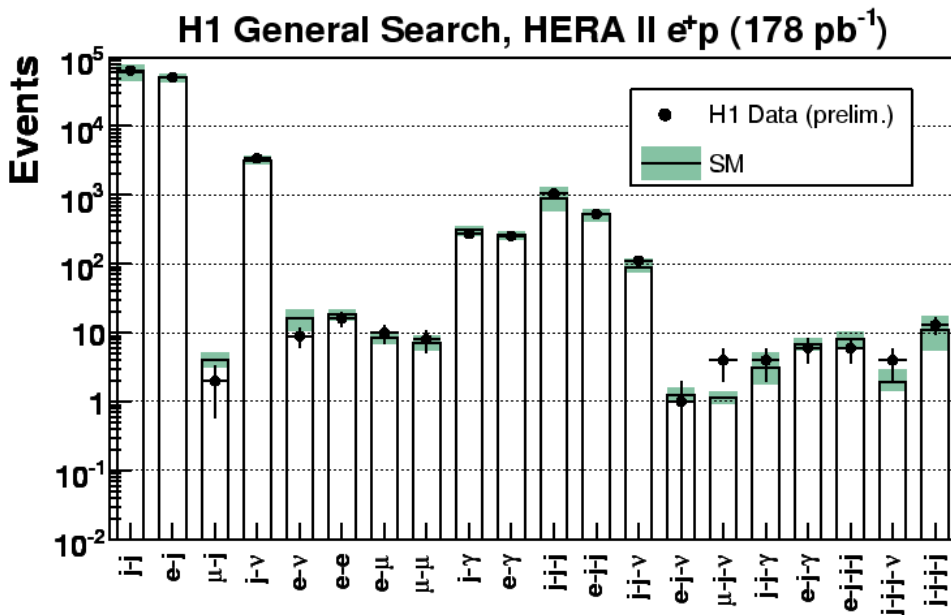
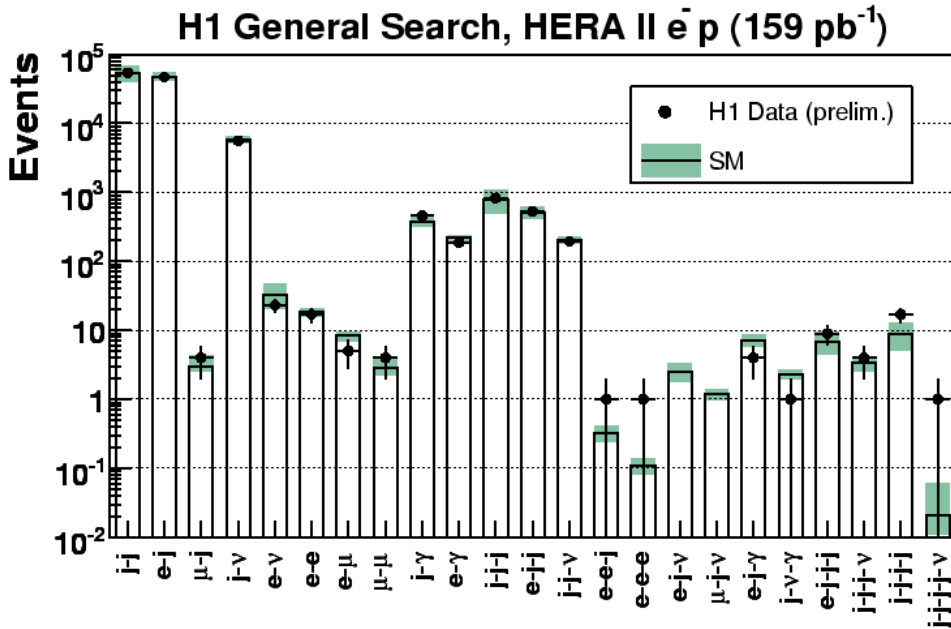

- Combined HERA results clarify e.g. H1 isolated high  $p_T$  leptons with missing  $p_T$
- No really significant signals
- Detectors well understood!

# A(nother) HERA Timeline

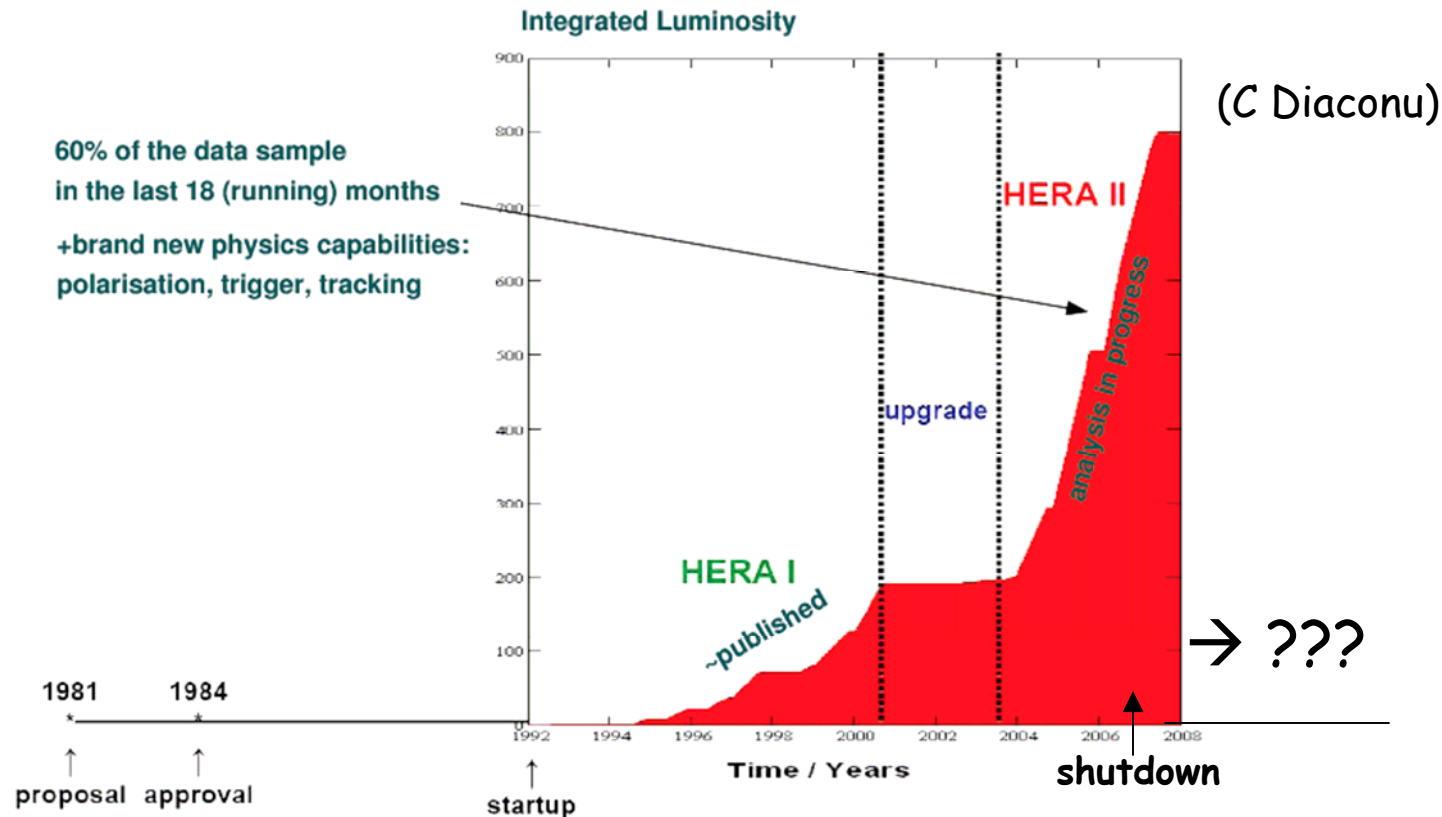

... very few publications on HERA-II so far!.. best still to come  
... complicated final states take time (& experts) to analyse!

*"UK physicists are still very much engaged in getting the most accurate data analysed and published on subjects of key importance for HERA, for QCD and in the preparation For the LHC. The projects require modest travel and common Fund support (mainly computing) in order to produce the final publications which capitalise on two decades of UK investment"* [Particle Physics Consultation Panel to STFC Programmatic Review:]



The LHC is  
the Future!



Can the unprecedented  
LHC energy and  
intensity be exploited  
for DIS?

"... the LHeC is already  
half built" [J Engelen]

"... it would be a waste  
not to exploit the 7TeV  
beams for ep and eA  
physics at some stage  
during the LHC time"

[G. Altarelli]

# HERA-LHC Workshop ... (see also PDF4LHC)

The image displays four posters for the HERA AND THE LHC workshops, arranged in a row. Each poster features an aerial view of the HERA accelerator facility and lists the workshop's date, location, topics, and participant count.

- 1st Workshop:** March 2004 - January 2005, CERN, Geneva. Topics: Parton density functions, Multijet final states and energy flow, Heavy quarks, Diffraction, Monte Carlo tools. (270 participants)
- 2nd Workshop:** 6-9 June 2006, CERN, Geneva. Topics: Parton density functions, Multijet final states and energy flow, Heavy quarks, Diffraction, Monte Carlo tools. (150 participants)
- 3rd Workshop:** 12-16 March 2007, DESY Hamburg. Topics: Parton density functions, Multijet final states and energy flow, Heavy quarks, Diffraction, Monte Carlo tools. (160 participants)
- 4th Workshop:** 26-30 May 2008, CERN. Topics: Parton density functions, Multijet final states and energy flow, Heavy quarks, Diffraction, Monte Carlo tools. (190 participants)

## AIMS

- Identify & prioritise HERA measurements needed for LHC
- Transfer of knowledge between HERA & LHC communities
- Establish ongoing interaction HERA & LHC communities
- Quantify implication of HERA results
- Develop new experimental / theoretical tools
- Encourage theory / phenomenology efforts



# Some LHeC Context

The LHeC is not the first proposal for higher energy DIS, but it is the first with the potential for significantly higher luminosity than HERA ...

DESY 06-006  
Cockcroft-06-05

Lepton-Proton Scattering Facilities

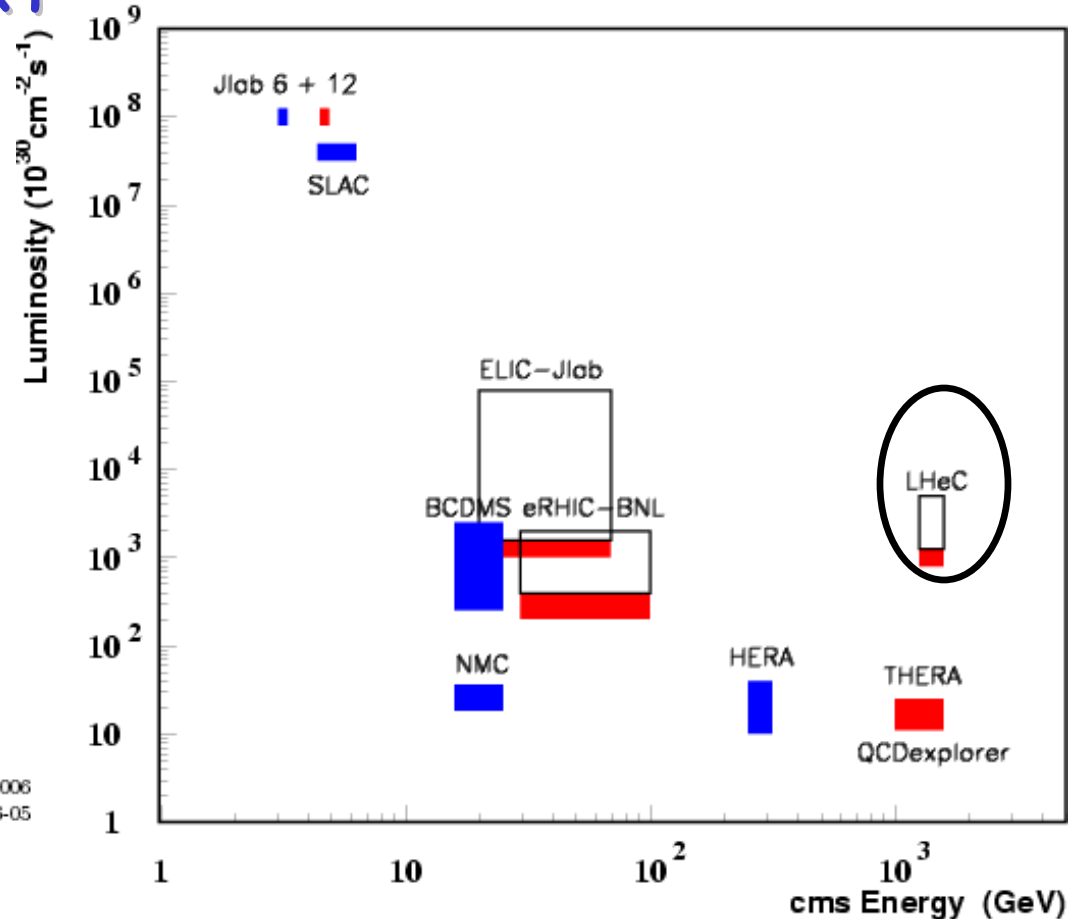

Deep Inelastic Electron-Nucleon Scattering at the LHC\*

J. B. Dainton<sup>1</sup>, M. Klein<sup>2</sup>, P. Newman<sup>3</sup>, E. Perez<sup>4</sup>, F. Willeke<sup>2</sup>

<sup>1</sup> Cockcroft Institute of Accelerator Science and Technology, Daresbury International Science Park, UK

<sup>2</sup> DESY, Hamburg and Zeuthen, Germany

<sup>3</sup> School of Physics and Astronomy, University of Birmingham, UK

<sup>4</sup> CE Saclay, DSM/DAPNIA/Spp, Gif-sur-Yvette, France

... achievable with a new electron accelerator at the LHC ...

[JINST 1 (2006) P10001]

# Some committees were set up ...



**Scientific Advisory Committee**

- Guido Altarelli (Rome)
- Stan Brodsky (SLAC)
- Allen Caldwell (MPI Munich)
- Swapan Chattopadhyay (Cockcroft)
- John Dainton (Liverpool)
- John Ellis (CERN)
- Jos Engelen (CERN)
- Joel Feltesse (Saclay)
- Lev Lipatov (St.Petersburg)
- Roger Caroby (CERN)
- Rolf Heuer (DESY)
- Roland Horisberger (PSI)
- Young Kee Kim (Fermilab)
- Aharon Levy (Tel Aviv)
- Richard Milner (Bates)
- Steven Myers (CERN)
- Alexander Skrinsky (Novosibirsk)
- Anthony Thomas (Jlab)
- Steven Vigdor (BNL)
- Ferdinand Willeke (BNL)
- Frank Wilczek (MIT)

**Steering Committee**

- Oliver Bruening (CERN)
- John Dainton (Cockcroft)
- Albert DeRoeck (CERN)
- Stefano Forte (Milano)
- Max Klein - chair (Liverpool)
- Paul Newman (Birmingham)
- Emmanuelle Perez (CERN)
- Wesley Smith (Wisconsin)
- Bernd Surrow (MIT)
- Katsuo Tokushuku (KEK)
- Urs Wiedemann (CERN)

Will discuss next steps and organisation to achieve the CDR goal



... after further studies, discussions with CERN accelerator experts and a presentation to plenary ECFA (M Klein) ...

Summary and Proposal as endorsed by ECFA (30.11.2007)

As an add-on to the LHC, the LHeC delivers in excess of 1 TeV to the electron-quark cms system. It accesses high parton densities 'beyond' what is expected to be the unitarity limit. Its physics is thus fundamental and deserves to be further worked out, also with respect to the findings at the LHC and the final results of the Tevatron and of HERA.

First considerations of a ring-ring and a linac-ring accelerator layout lead to an unprecedented combination of energy and luminosity in lepton-hadron physics, exploiting the latest developments in accelerator and detector technology.

It is thus proposed to hold two workshops (2008 and 2009), under the auspices of ECFA and CERN, with the goal of having a Conceptual Design Report on the accelerator, the experiment and the physics. A Technical Design report will then follow if appropriate.

... Nuclear physics also took an interest ...

## Electron-Proton/Ion Collider



- Options

- Europe
  - LHeC
  - $\bar{e} + \bar{p}$  Collider @ FAIR
- USA
  - ELIC @ JLab
  - eRHIC @ BNL

- NuPECC working group

- Tullio Bressani, Jens Jørgen Gaardhøje, G. Rosner (chair), H. Ströher

- Input to

- NuPECC Report 2009
- NuPECC's next Long Range Plan
  - Start preparation @ mtg. in Glasgow, Oct. 2008
  - Town meetings, working groups in 2009/10
  - Publication ~2010/11

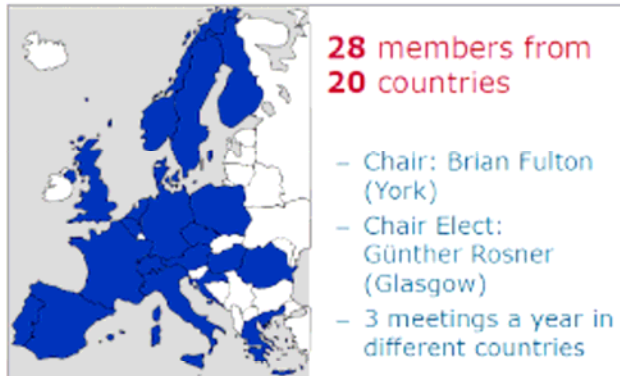

... a working group structure agreed and convenors invited ...



First ECFA-CERN Workshop on the LHeC Divonne 1.-3.9.08

**Accelerator Design [RR and LR]**

Oliver Bruening (CERN),  
John Dainton (CI/Liverpool)  
**Interaction Region and Fwd/Bwd**  
Bernhard Holzer (DESY),  
Uwe Schneekloth (DESY),  
Pierre van Mechelen (Antwerpen)

**Detector Design**

Peter Kostka (DESY),  
Rainer Wallny (UCLA),  
Alessandro Polini (Bologna)

**New Physics at Large Scales**

Emmanuelle Perez (CERN),  
Georg Weiglein (Durham)

**Precision QCD and Electroweak**

Olaf Behnke (DESY),  
Paolo Gambino (Torino),  
Thomas Gehrmann (Zuerich)

**Physics at High Parton Densities**

Nestor Armesto (CERN),  
Brian Cole (Columbia),  
Paul Newman (B'ham),  
Anna Stasto (MSU)



... first workshop took place in September 2008, Divonne ...  
→ Eclectic mix of accelerator experts, experimentalists and theorists (91 participants)



Monday 01 September 2008

Registration - Hall d'accueil (12:30-14:00)

# Agenda of Divonne Workshop

## Opening - Amphitheatre (14:00-16:30)

- Co-conveners: Ellis, John

time	[id]	title	presenter
14:00	[0]	Welcome Address	ENGELEN, Joe
14:15	[1]	Opening Remarks from ECFA	MEIER, Karlheinz
14:30	[4]	Opening Remarks from NuPEC	ROGNER, Guenter
14:45	[2]	Opening Lecture - "Deep Inelastic Scattering in the LHC time"	ALTARELLI, Guido
15:45	[3]	Steering Group Report	KLEIN, Max

## Accelerator Overview - Auzone (17:00-19:05)

time	[id]	title	presenter
17:00	[41]	Discussion	
17:45	[37]	Boundary conditions for the Interaction Region design	SCHNEKLOTH, Uwe
18:15	[38]	Interaction Region design for a ring-ring option	HOLZER, Bernhard
18:40	[39]	Interaction Region design for a ring-linear option	TOMAS, Rogelio

## Physics Overview - Barbillaine (17:00-19:00)

time	[id]	title	presenter
17:00	[9]	LHC Physics Overview	BRONSKY, Stan
18:00	[10]	QCD in the High Energy Limit	BARTHEL, Jochen

Tuesday 02 September 2008

## Accelerator & IR Design - Auzone (09:00-12:00)

time	[id]	title	presenter
09:00	[40]	Ring-Linear option: various operation modes and performance reaches	ZIMMERMANN, Frank
09:30	[42]	Magnet design issues and options for an LHC Interaction Region	RUSSENSCHUCK, Stephan
10:00	[43]	Operation with large crossing angles and the required CRAB cavity parameters	CALAGA, Rene
10:30		coffee break	
11:00	[44]	Summary of the main parameters for the ring-ring option	ZOWETT, John
11:30	[45]	Fingering layout and bypass design	BURKHARDT, Helmut

## Detector Design - Barbillaine (09:00-12:00)

time	[id]	title	presenter
09:00	[62]	Introduction and session organization	POLINI, Alessandro KOSTKA, Peter WALLINY, Rainer
09:15	[63]	Silicon Pixel detectors for Tracking	WERMES, Norbert
10:00	[64]	EDSO and silicon radiation hardness	MULL, Michael
10:30		coffee break	
11:00	[65]	Present & Future Collider Triggers	SMITH, Wesley
11:20	[66]	Triggers and displaced vertices (CDF SVT)	CERRI, Alessandro
11:40	[67]	The CMS Hadron Calorimeter and upgrade scenarios	SKUSA, Andri

## QCD and Low x ep Observables and PDFs - Amphitheatre (09:00-12:00)

time	[id]	title	presenter
09:00	[11]	Precision Physics with Parton Distributions	VOGT, Andreas
09:30	[12]	Structure Functions and PDFs at the LHC	KLEIN, Max
09:50	[13]	Neural network approach to parton distributions	BOGUCHACON, Juan
10:10	[14]	Expectations for $\alpha_s$	KLUSE, Thomas
10:30		coffee break	
11:00	[15]	Heavy Flavour and Jet Observables at the LHC	BEHNKE, Otf
11:20	[17]	More Low-x Observables at the LHC	NEWMAN, Paul
11:40	[16]	Forward Jet/Parton Cascade Dynamics at LHC (bc)	FUNO, Haruo

## Accelerator & IR & Detector - Auzone (14:00-16:00)

time	[id]	title	presenter
14:00	[49]	Active magnets	GREENSHAW, Tim
14:20	[48]	Magnet Options for LHC detector	TEN KATE, Henno
14:40	[46]	e-SBHC machine aspects	LITVINENCO, Vladimir

16:30	[26]	Higgs $\rightarrow$ b-bar Coupling at LHC	KOAY, Sue Ann
16:50	[80]	Higgs cross sections at LHC	KLEIN, Uta
17:10	[27]	Backgrounds to Higgs production at the LHC	KUZE, Masahiro
17:30	[28]	Dirac-Yan, new physics and high x PDFs	PEREZ, Emmanuelle
17:50	[29]	Electroweak precision physics before and after LHC	DEBRASSI, Giuseppe

## Low x ep and eA Physics at LHC and LHeC - Barbillaine (16:30-19:00)

time	[id]	title	presenter
16:30	[32]	Low x QCD with protons and nuclei at LHC	D'ENTERRIA, David
16:50	[33]	What to expect on low x from ATLAS	CAMPANELLI, Mario
17:10	[34]	From ep to A-B Collisions	ARMESTO, Nestor
17:30	[36]	Protonic photons as a tool for nuclear PDFs	ARLETO, Francesco
17:50	[35]	Concluding discussion and plans on low x	

15:00	[47]	IR Design for the e-SBHC project	MCINTAG, Christoph
15:20	[50]	IR Design proton optics	HOLZER, Bernhard
15:40	[51]	IR Design electron optics	KLEIN, Alexander

## New Physics at the LHeC - Barbillaine (14:00-16:01)

time	[id]	title	presenter
14:00	[18]	Introduction	PEREZ, Emmanuelle
14:30	[19]	Excited Fermions	TRINH, Nguyen
15:00	[20]	Single Leptoquark Production in pp	PAPADOPOULOU, Theodoros
15:30	[30]	Single Top Production	BRANDT, Gerhard

## Parton Saturation at the LHeC - theory and experiment - Amphitheatre (14:00-16:00)

time	[id]	title	presenter
14:00	[21]	Gluon density in BKSL DAF-Pomerons at HERA and its implication for LHC and KOWALSKI, Horia LHeC	
14:20	[22]	Saturation effects in final states and total cross sections due to CCFM with absorptive boundary	KUTAK, Krzysztof
14:40	[23]	SD tiny black holes and perturbative saturation	SABIDO VERA, Agustín
15:00	[24]	Establishing/falsifying saturation at LHeC	BOGUCHACON, Juan
15:20	[25]	Establishing/falsifying parton saturation in low x ep at LHeC	NEWMAN, Paul

## Accelerator & IR Design - Auzone (16:30-19:00)

time	[id]	title	presenter
16:30	[74]	Space requirements for cavities, klystrons and power converters in the LHC tunnel bypass areas	LINSINGER, Terese
16:50	[75]	Synergies of the required LHeC R efforts with other existing projects	NN
17:10	[76]	Polarisation	BARKER, Desmond
17:30	[77]	Double Quad Design	PAOLONI, Eugenio BETTONI, Simona
17:50	[78]	Synchrotron Light	MAGORNY, Boris
18:10	[79]	Discussion	

## Detector Design - Foyer des artistes (16:30-19:00)

time	[id]	title	presenter
16:30	[71]	Compact gaseous pixel detector R&D	KOFFEMAN, Erik
17:00	[72]	CAJICE calorimeters for the LHC	SIMON, Frank
17:30	[73]	Detector Design WG open discussion	NN

Wednesday 03 September 2008

## Reports from Working Groups - Amphitheatre (09:00-12:30)

time	[id]	title	presenter
09:00	[56]	Physics at High Parton Densities (ep and eA)	ARMESTO, Nestor NEWMAN, Paul
09:30	[57]	Precision Investigations of QCD and Electroweak Interactions	BEHNKE, Otf
10:00	[58]	New Physics at Large Scales	WEGLEIN, Georg
10:30		coffee break	
11:00	[59]	Detector Design	POLINI, Alessandro WALLINY, Rainer KOSTKA, Peter
11:30	[60]	Interaction region and Forward/Backward Detectors	HOLZER, Bernhard
12:00	[61]	Accelerator Design	BRUNING, Oliver

# How Could ep be Done using LHC?

... whilst allowing simultaneous ep and pp running ...

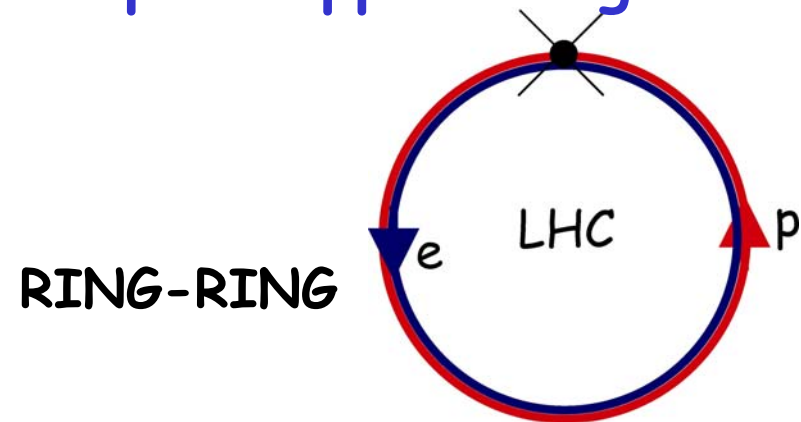
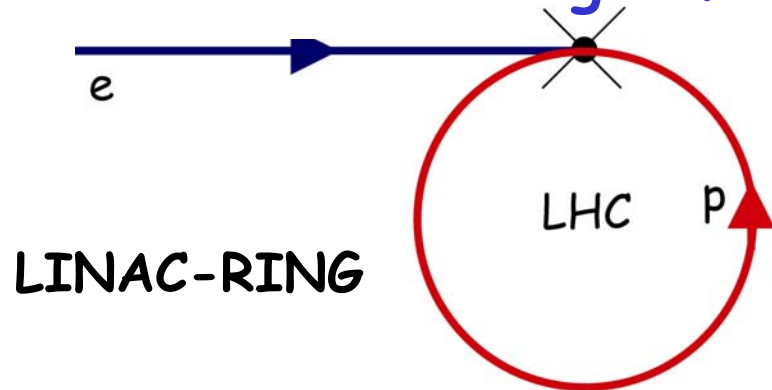

- Previously considered as 'QCD explorer' (also THERA)
- Reconsideration (Chattopadhyay, Zimmermann et al.) recently
- Main advantages: low interference with LHC,  $E_e \rightarrow 140 \text{ GeV} ++$ , LC relation
- Main difficulties: lower luminosity  $\sim 0.5 \cdot 10^{32} \text{ cm}^{-2} \text{ s}^{-1}$  (?) at reasonable power, no previous experience exists

- First considered (as LEPxLHC) in 1984 ECFA workshop
- Recent detailed re-evaluation with new e ring (Willeke)
- Main advantage: high peak lumi obtainable ( $10^{33} \text{ cm}^{-2} \text{ s}^{-1}$ )
- Main difficulties: building round existing LHC, synchrotron limits e beam energy (70GeV) and lifetime

# Kinematics & Motivation (70 GeV x 7 TeV ep)

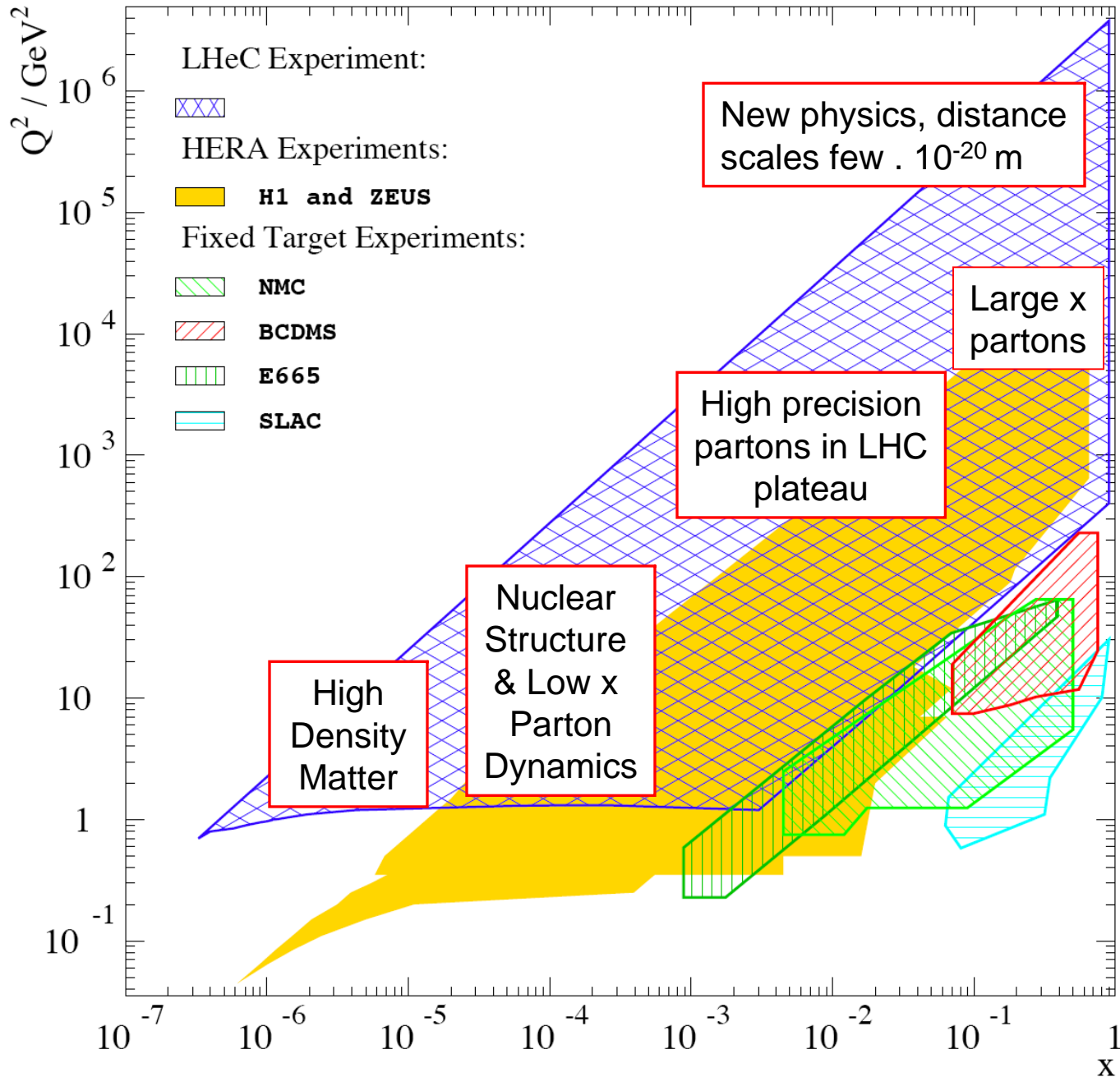

$$\sqrt{s} = 1.4 \text{ TeV}$$

- High mass ( $M_{eq}$ ,  $Q^2$ ) frontier
- EW & Higgs
- $Q^2$  lever-arm at moderate & high  $x \rightarrow$  PDFs
- Low  $x$  frontier  $\rightarrow$  novel QCD ...

$$x \geq 5 \cdot 10^{-7} \text{ at } Q^2 \leq 1 \text{ GeV}^2$$



# The Luminosity v Acceptance Conundrum

- As for HERA-I v HERA-II, low  $\beta$  focusing quadrupoles around interaction region can improve lumi by a factor  $\sim 10$
- However, acceptance near beam-pipe is compromised
  - loss of low  $x / Q^2$  acceptance
  - loss of high  $M$  acceptance
  - poorer HFS measurements

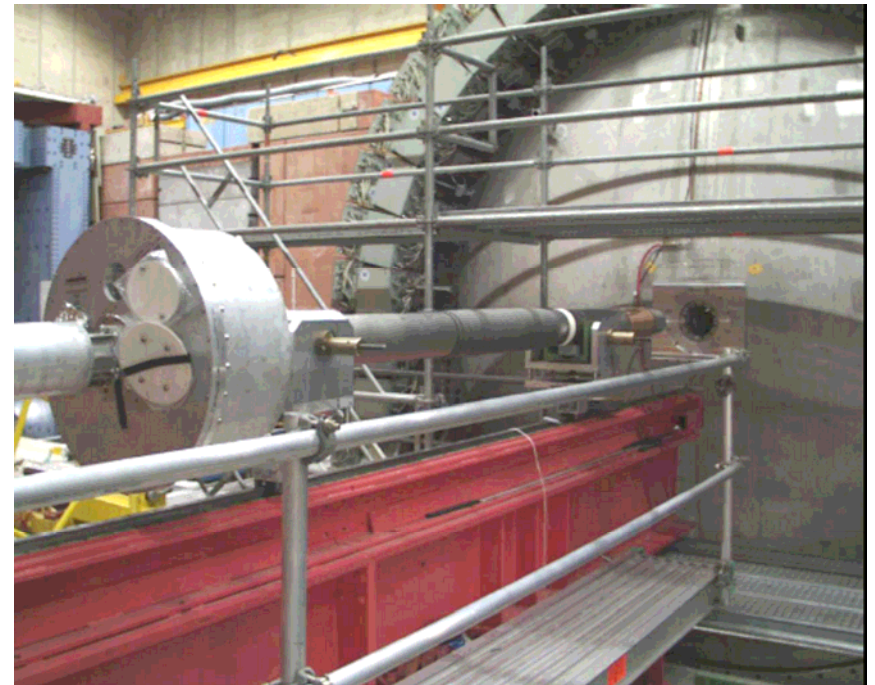
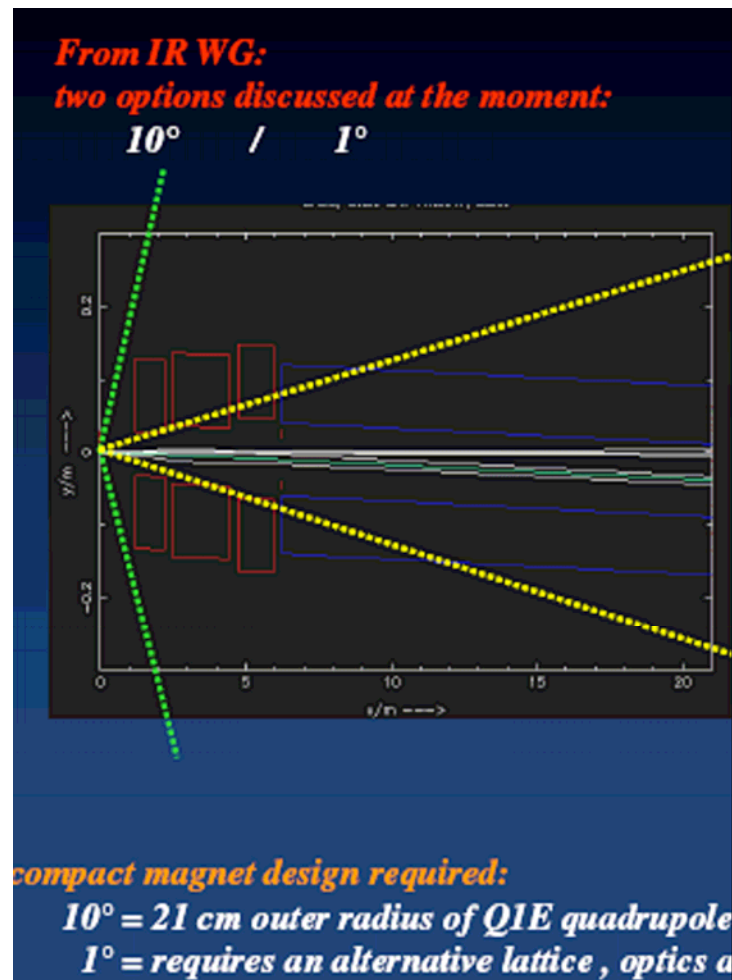

# A Working Scenario for First Physics Studies

Assume a 70 GeV electron beam and lumi of 1-10 fb<sup>-1</sup> / year  
Requirements to reach a per-mil  $\alpha_s$  (c.f. 1-2% now) ...

The new collider ...

- should be ~100 times more luminous than HERA

The new detector

- should be at least 2 times better than H1 / ZEUS

Lumi = 10 <sup>33</sup> cm <sup>-2</sup> s <sup>-1</sup>	(HERA 1-5 × 10 <sup>31</sup> cm <sup>-2</sup> s <sup>-1</sup> )
Acceptance 10-170° (→179°?)	(HERA 7-177°)
Tracking to 0.1 mrad	(HERA 0.2 – 1 mrad)
EM Calorimetry to 0.1%	(HERA 0.2-0.5%)
Had calorimetry to 0.5%	(HERA 1%)
Luminosity to 0.5%	(HERA 1%)

First `pseudo-data' for  $F_2$ ,  $F_L$ ,  $F_2^D$  produced on this basis ...

# Working Group on New Physics at High Scales

## New physics at large scales: what is the physics potential of LHeC?

[Weiglein]

- Is there potential for new physics studies beyond the  $eeqq$  contact interaction (see G. Altarelli's talk)?
- Can new physics be observed at the LHeC that did not show up at the LHC?
- If not, can LHeC + LHC measurements yield added value compared to LHC alone?

... LHeC may have competitive sensitivity to LHC in BSM areas where HERA was also strong compared with Tevatron ...



# Lepton-quark Bound States

- Leptoquarks appear in many extensions to SM... explain apparent symmetry between lepton and quark sectors.

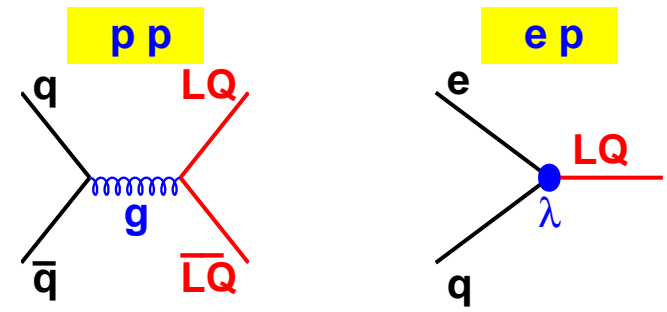

Yukawa coupling,  $\lambda$

- Scalar or Vector color triplet bosons carrying L, B and fractional Q, complex spectroscopy?

- (Mostly) pair produced in pp, single production in ep.

- LHeC sensitivity (to  $\sim 1.5$  TeV) similar to LHC, but can determine quantum numbers / spectroscopy (fermion #, spin, chiral couplings ...)

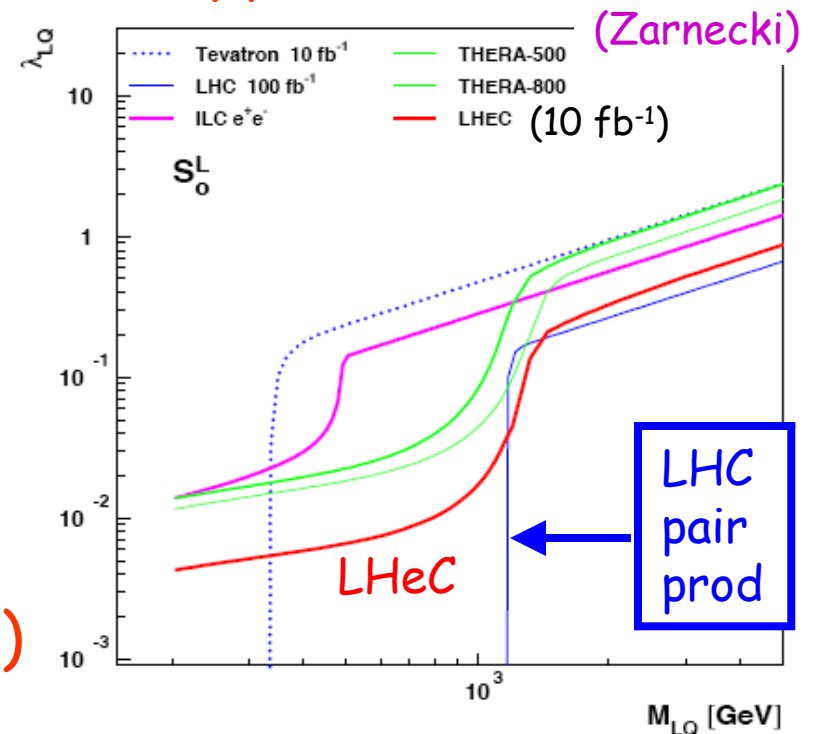

# Rp Conserving Supersymmetry

$\tan \beta = 10, M_2 = 380 \text{ GeV}, \mu = -500 \text{ GeV}$

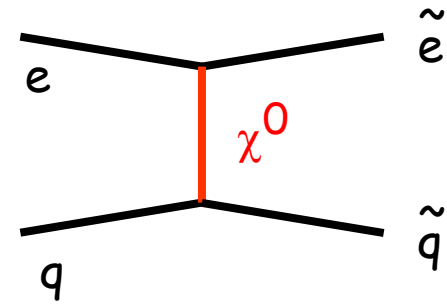

Pair production via t-channel exchange of a neutralino.

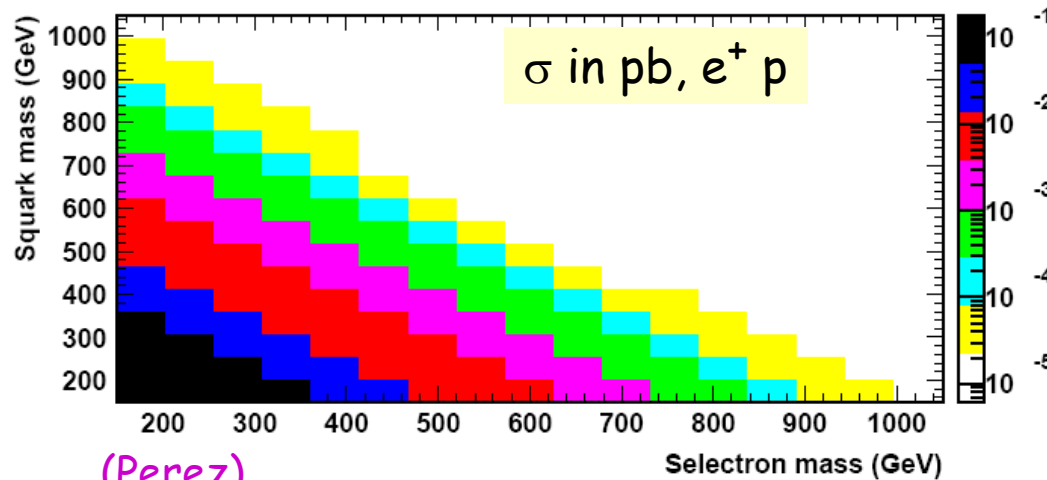
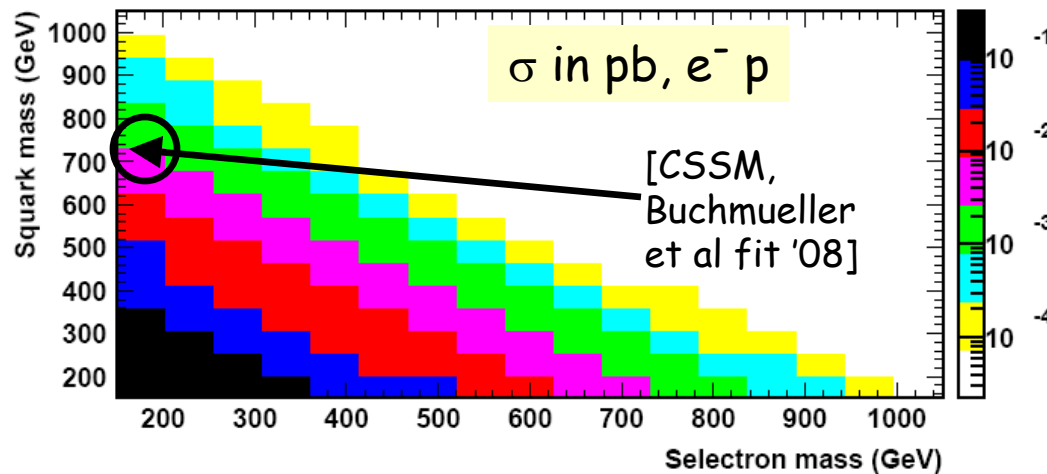

(Perez)

Cross-section sizeable for  $\Sigma M < 1 \text{ TeV}$  i.e. if squarks are "light", could observe selectrons up to  $\sim 500 \text{ GeV}$ , a little beyond LHC?

- Total cross section for  $l^*$  productions through GM interaction at LHeC, assuming  $M_{e^*} = \Lambda$

↳ comparison with HERA and LHC

# Excited Leptons

[Trinh]

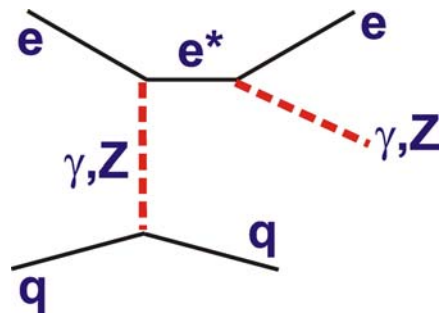
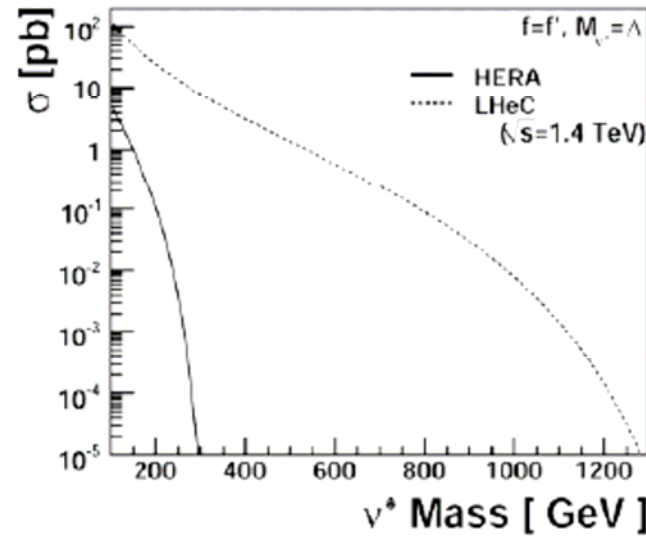
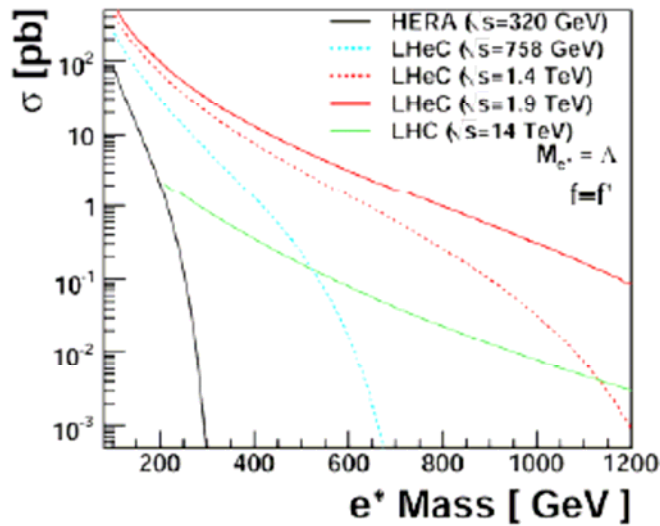

LHeC gives best sensitivity in this scenario ...

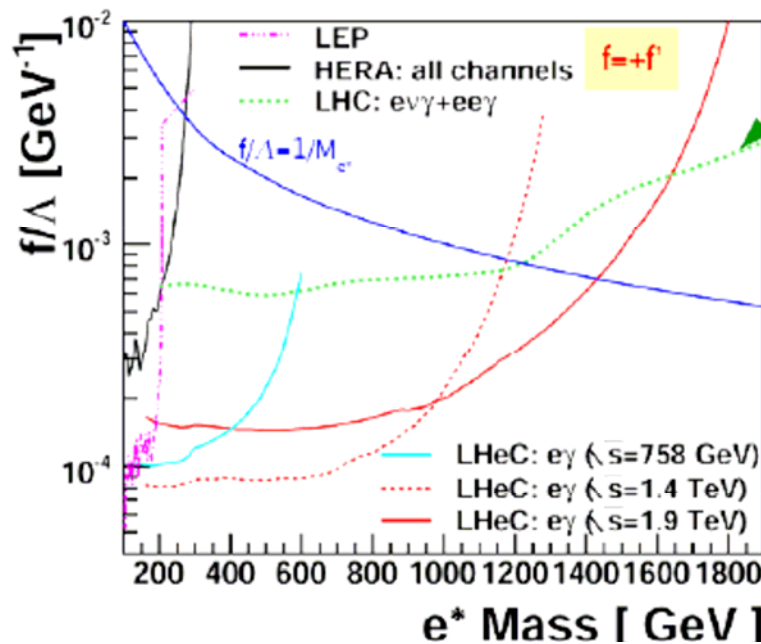

[ Phys. Rev D 65 (2002) 075003 ]

**LHeC sensitivity,  
with  $L=10 \text{ fb}^{-1}$  for  $E_e=70/20 \text{ GeV}$   
with  $L=1 \text{ fb}^{-1}$  for  $E_e=140 \text{ GeV}$**



# Precision Electroweak and QCD Group

Electroweak & QCD wishlist for LheC [Behnke]

---

WW  $\rightarrow$  Higgs

Precise electroweak couplings  $a_q, v_q$

$\alpha_s$  @  $\sim 1\%$  precision

w/d for  $x \rightarrow 1$

$g(x)$  for  $x > 0.1$

intrinsic c, b, t  $x > 0.1$ ?  
Effective b-density at  $x = 0.01$

XF3 valence quarks down to small  $x$

Direct  $s(x)$

Precise F1 and  $g(x)$  at low  $x$

+much much many more...



# Another version of the wish list ...

## *Novel Aspects of QCD in ep scattering*

- **Clash of DGLAP and BFKL with unitarity: saturation phenomena; off-shell effects at high  $x$**
- **Heavy quark distributions *do not* derive exclusively from DGLAP or gluon splitting -- **component intrinsic to hadron wavefunction:**  
Intrinsic  $c(x, Q)$ ,  $b(x, Q)$ ,  $t(x, Q)$ :**
- **Hidden-Color of Nuclear Wavefunction**
- **Antishadowing is quark specific!**
- **Polarized  $u(x)$  and  $d(x)$  at large  $x$ ; duality**
- **Virtual Compton scattering : DVCS, DVMS, GPDs;  $J=0$  fixed pole reflects elementary source of electromagnetic current**
- **Initial- and Final-State Interactions: leading twist SSA, DDIS**
- **Direct Higher-Twist Processes; Color Transparency**

... some examples follow ...

# Higgs Production

## H production at LHeC

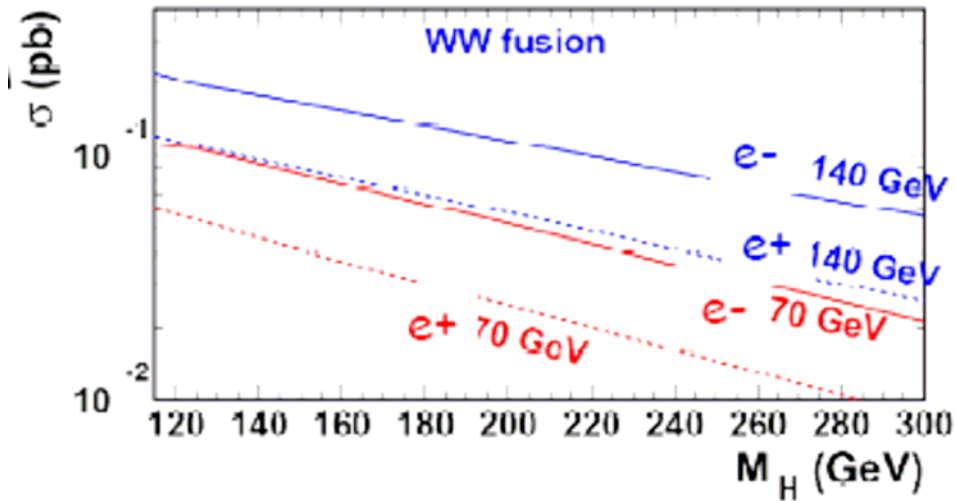

- Apply eta cuts on ALL final states

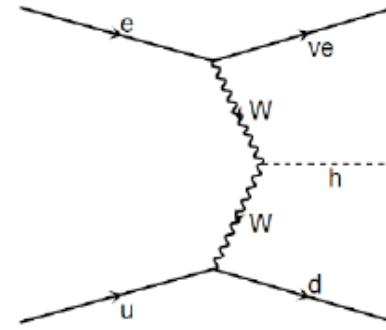
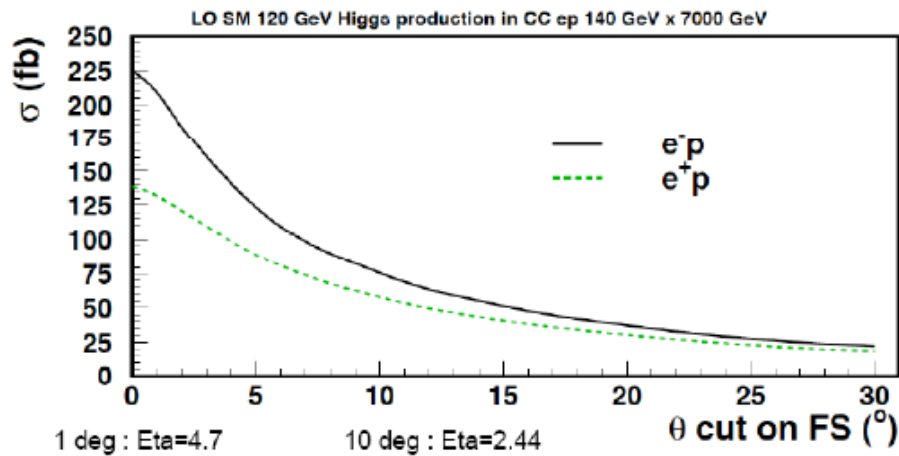

[U Klein,  
Kniehl,  
Perez,  
Khuze]

Sizeable CC (WW) x-section  
(NC factor ~5 smaller)

- Novel production mechanism
- Clean(ish) ...  $H + j + p_{\uparrow}^{\text{miss}}$
- $b\bar{b}$  coupling to light H?

Acceptance is an issue ...

First background studies (jets  
in CC) underway ...



# High x Partons Limiting LHC Searches

Some BSM scenarios give deviations in high mass dijet spectra ... e.g. a model with extra dimensions ...

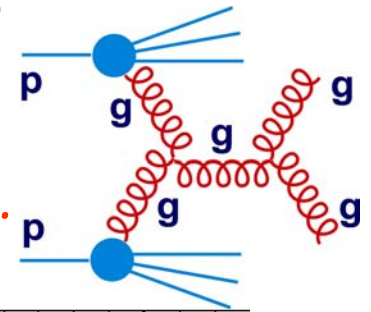

Mc=2TeV

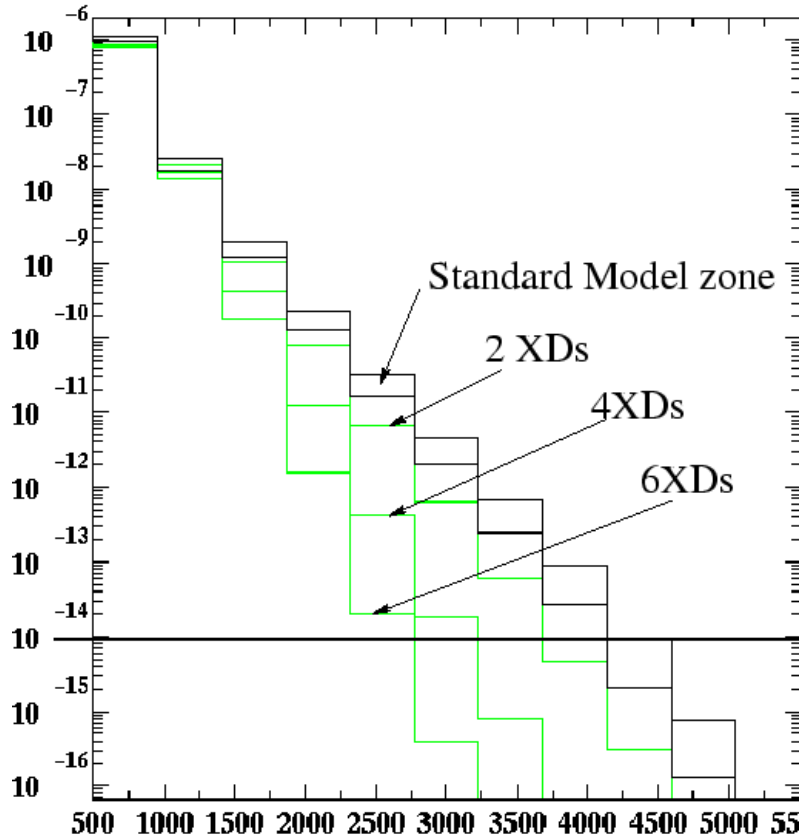

Mc=6TeV

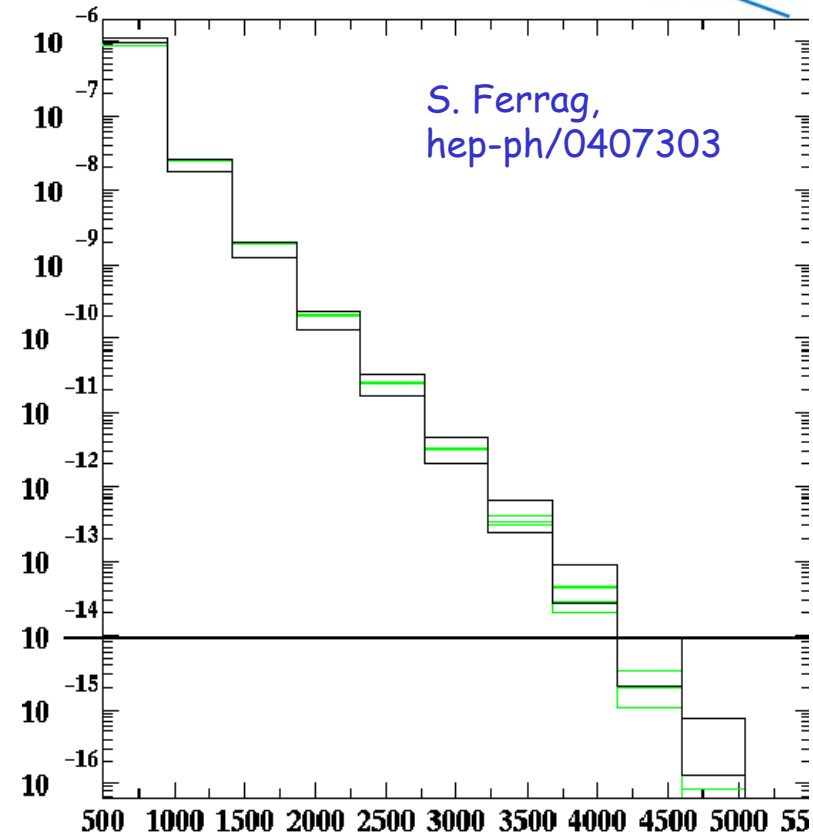

... in this example, high x PDF uncertainties reduce sensitivity to compactification scales from 6 TeV to 2 TeV for 2XDs

# LHeC Impact on High $x$ Partons and $\alpha_s$

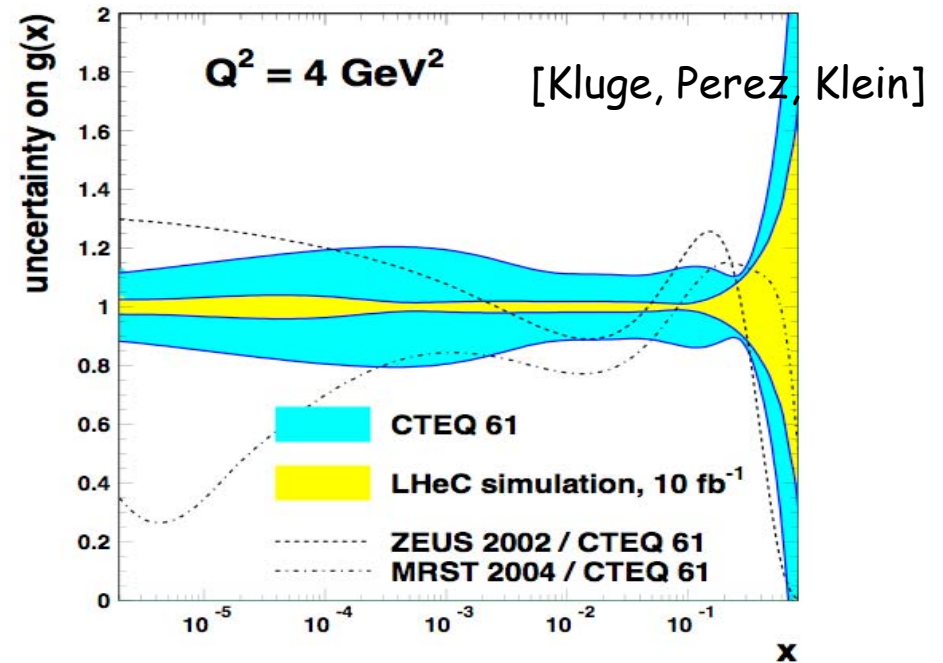
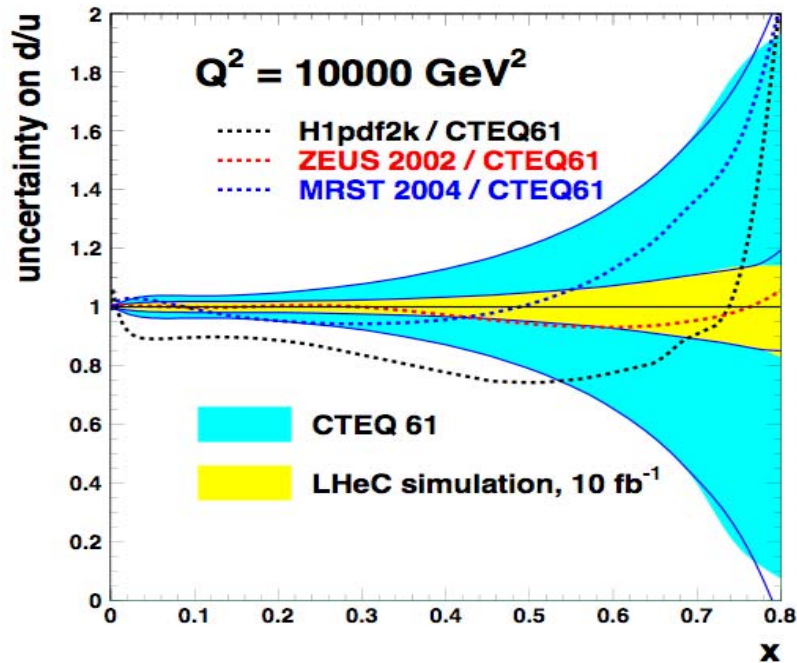

Full NC/CC sim (with systs giving per mil  $\alpha_s$ ) & NLO DGLAP fit using standard HERA technology...

... full flavour decomposition possible

... high  $x$  pdfs  $\rightarrow$  may help clarify LHC discoveries through interpretation of new states?

[Some of highest  $x$  improvement from param<sup>n</sup> extrapolation]

# Flavour Decomposition

## High precision $c, b$ measurements

(modern Si trackers, beam spot  $15 * 35 \mu\text{m}^2$ , increased HF rates at higher scales).

## Systematics at 10% level

- beauty is a low  $x$  observable!
- $s$  (&  $s$ bar) from charged current
- Similarly  $Wb \rightarrow t$ ?

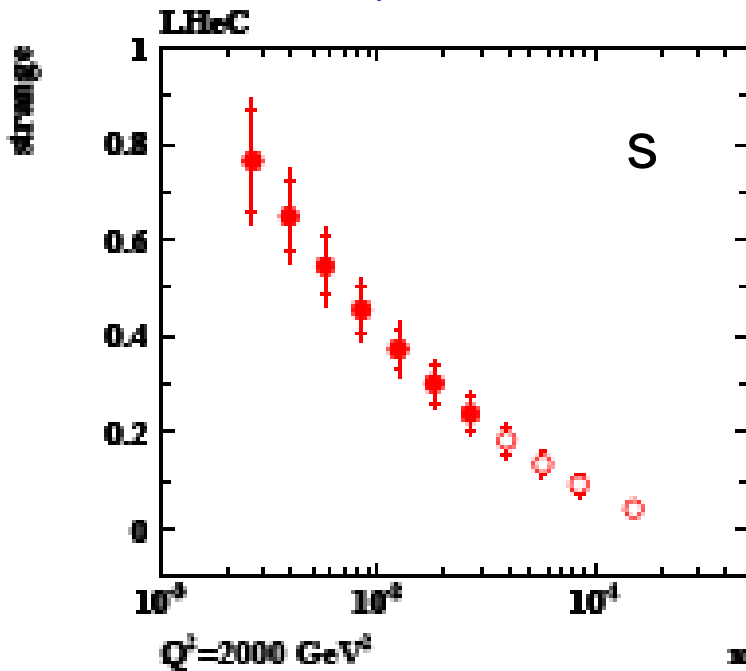
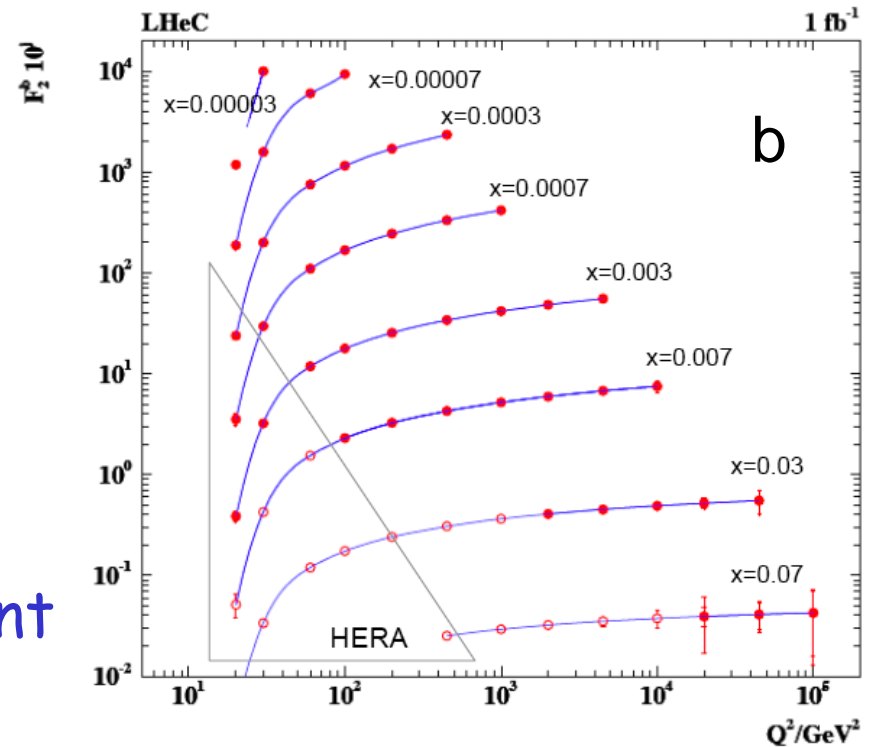

- LHeC  $10^0$  acceptance
- LHeC  $1^0$  acceptance

[Mehta, Klein]

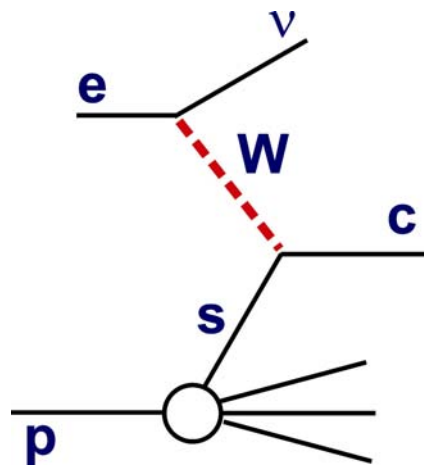

- (Assumes  $1 \text{ fb}^{-1}$  and
- 50% beauty, 10% charm efficiency
- 1%  $uds \rightarrow c$  mistag probability.
- 10%  $c \rightarrow b$  mistag)



# LHeC Kinematics for Low x Investigations

Access to  $Q^2=1 \text{ GeV}^2$   
 for all  $x > 5 \times 10^{-7}$   
 IF we have  
 acceptance  
 to  $179^\circ$

→ Without low  $\beta$   
 quads  $\sim 1 \text{ fb}^{-1} / \text{yr}$   
 ... definitive low x  
 facility (parton  
 saturation ?...)

LHeC – Low x Kinematics

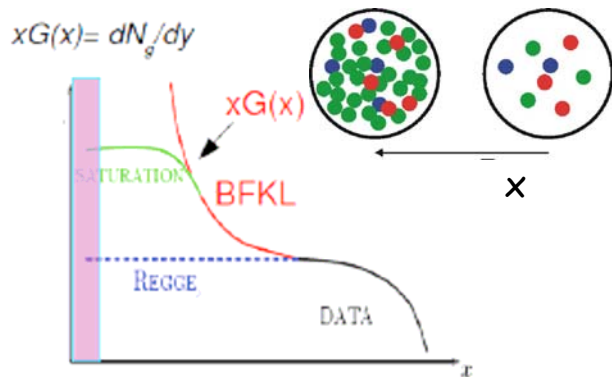
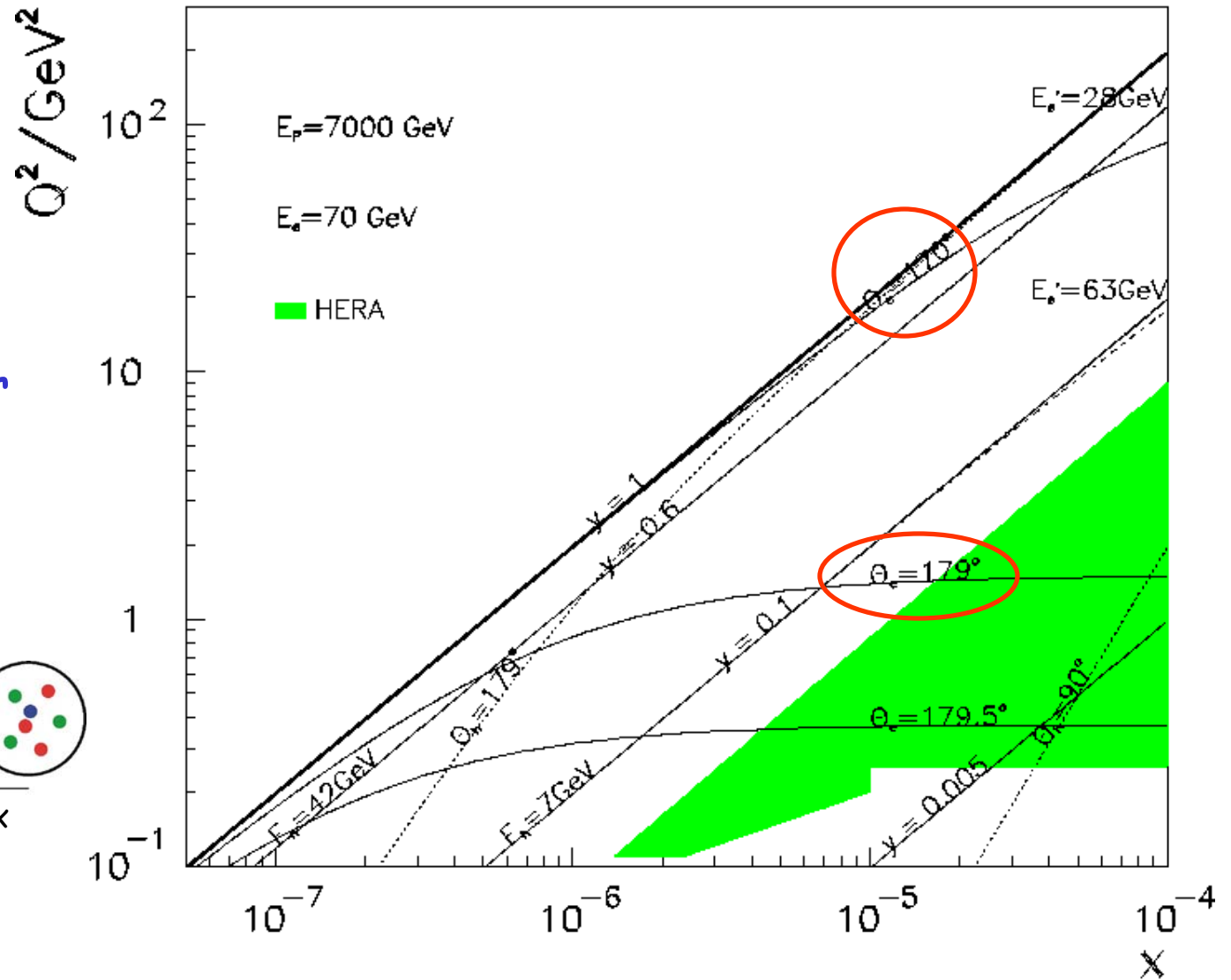

# More Low x Detector Considerations

- Low x studies require electron acceptance to  $1^\circ$  to beampipe

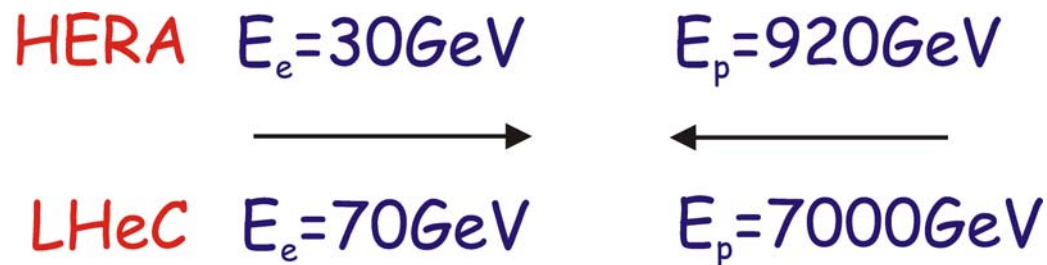

- Considerably more asymmetric beam energies than HERA!
  - Hadronic final state at newly accessed lowest x values goes central or backward in the detector ☺
  - At x values typical of HERA (but larger  $Q^2$ ), hadronic final state is boosted more in the forward direction.
- Study of low x /  $Q^2$  and of range overlapping with HERA, with sensitivity to energy flow in outgoing proton direction requires forward acceptance for hadrons to  $\sim 1^\circ$

# Forward Instrumentation and Jets

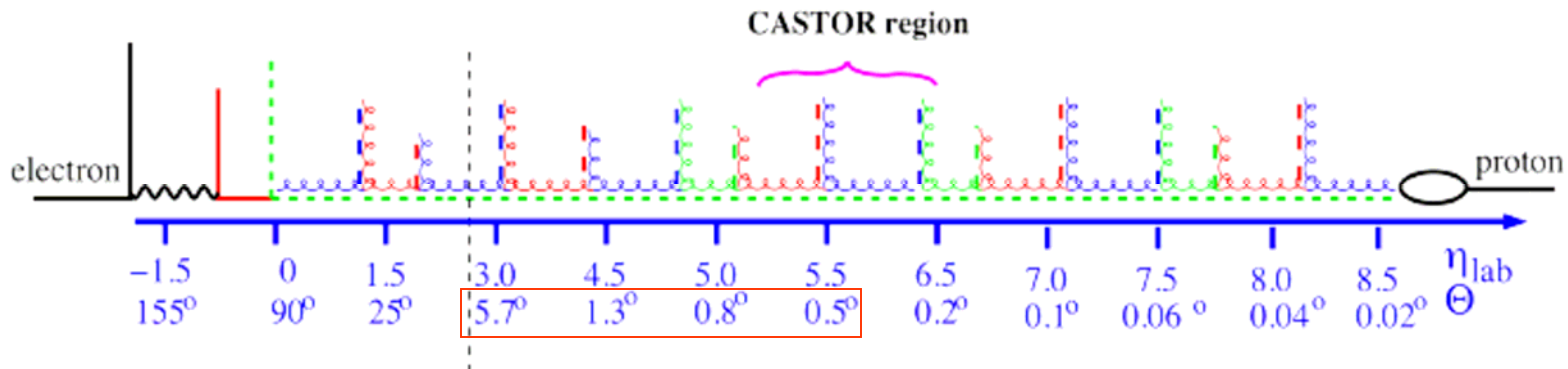

[Jung]

- DIS and forward jet:

$$x_{jet} > 0.03$$

$$0.5 < \frac{p_{t,jet}^2}{Q^2} < 2$$

x range (and sensitivity to novel QCD effects) strongly depend on  $\theta$  cut

Similar conclusions for  $\Delta\phi$  decorrelations between jets

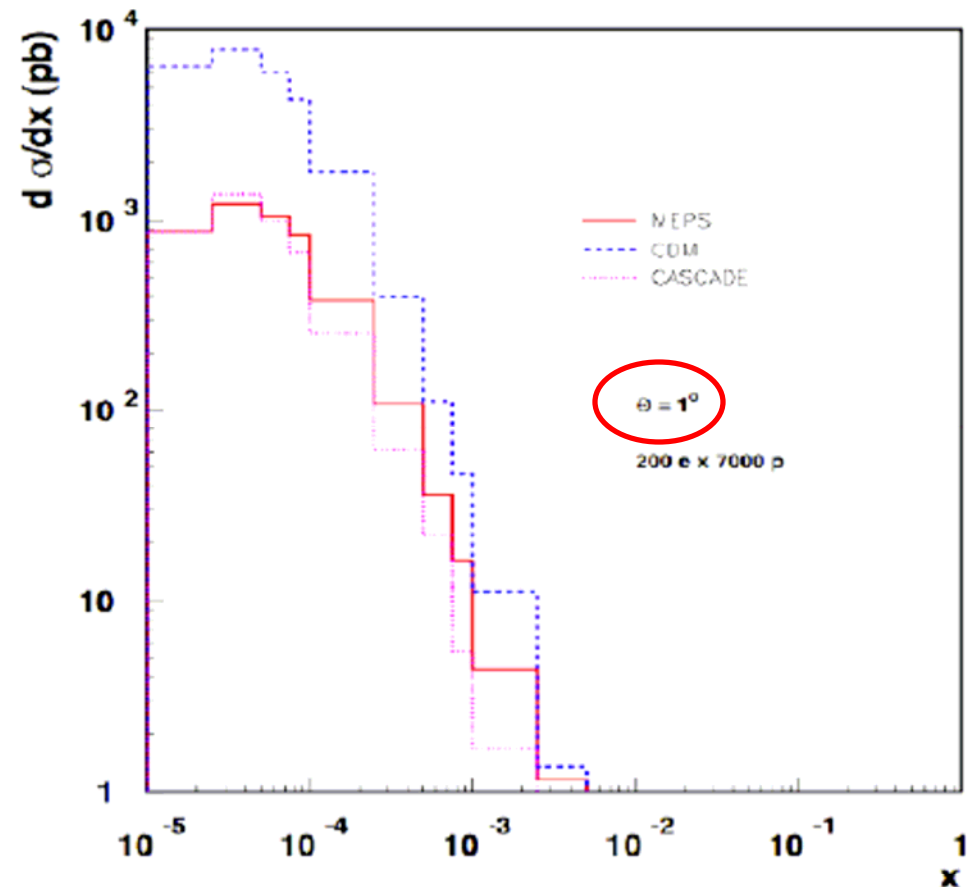

# Parton Saturation after HERA?

e.g. Forshaw, Sandapen, Shaw  
hep-ph/0411337,0608161  
... used for illustrations here

Fit inclusive HERA data  
using dipole models  
with and without parton  
saturation effects

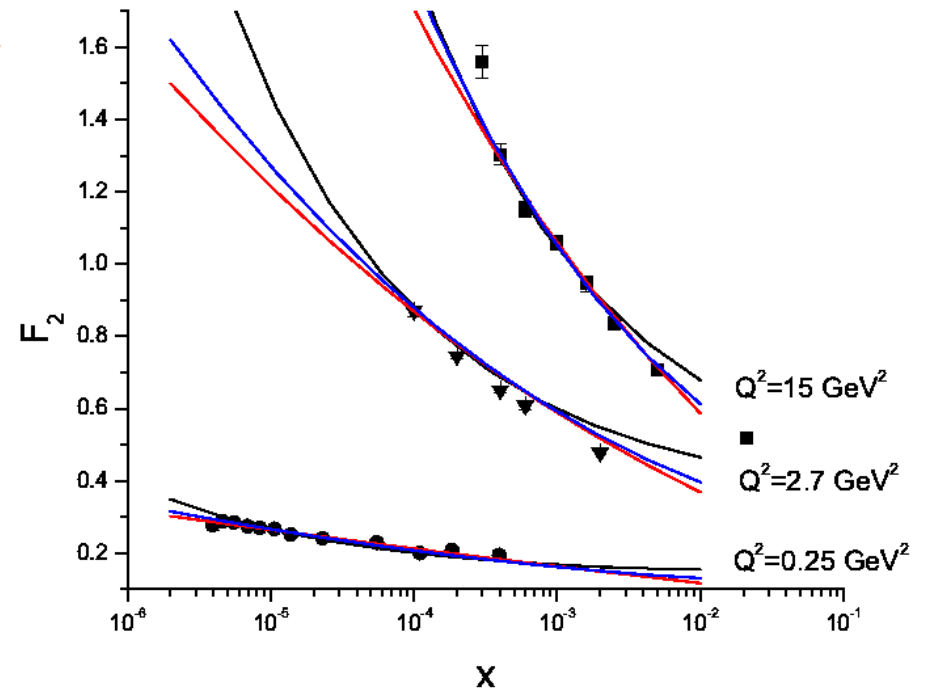

- FS04 Regge ( $\sim$ FKS): 2 pomeron model, no saturation
- FS04 Satn: Simple implementation of saturation
- CGC: Colour Glass Condensate version of saturation

- All three models can describe data with  $Q^2 > 1\text{GeV}^2$ ,  $x < 0.01$
- Only versions with saturation work for  $0.045 < Q^2 < 1\text{GeV}^2$
- ... any saturation at HERA not easily interpreted partonically



# Some models of low $x$ $F_2$ with LHeC Data

With  $1 \text{ fb}^{-1}$  (1 year at  $10^{33} \text{ cm}^{-2} \text{ s}^{-1}$ ),  $1^\circ$  detector:  
stat. precision  $< 0.1\%$ , syst, 1-3%

[Forshaw, Klein, PN, Soyez]

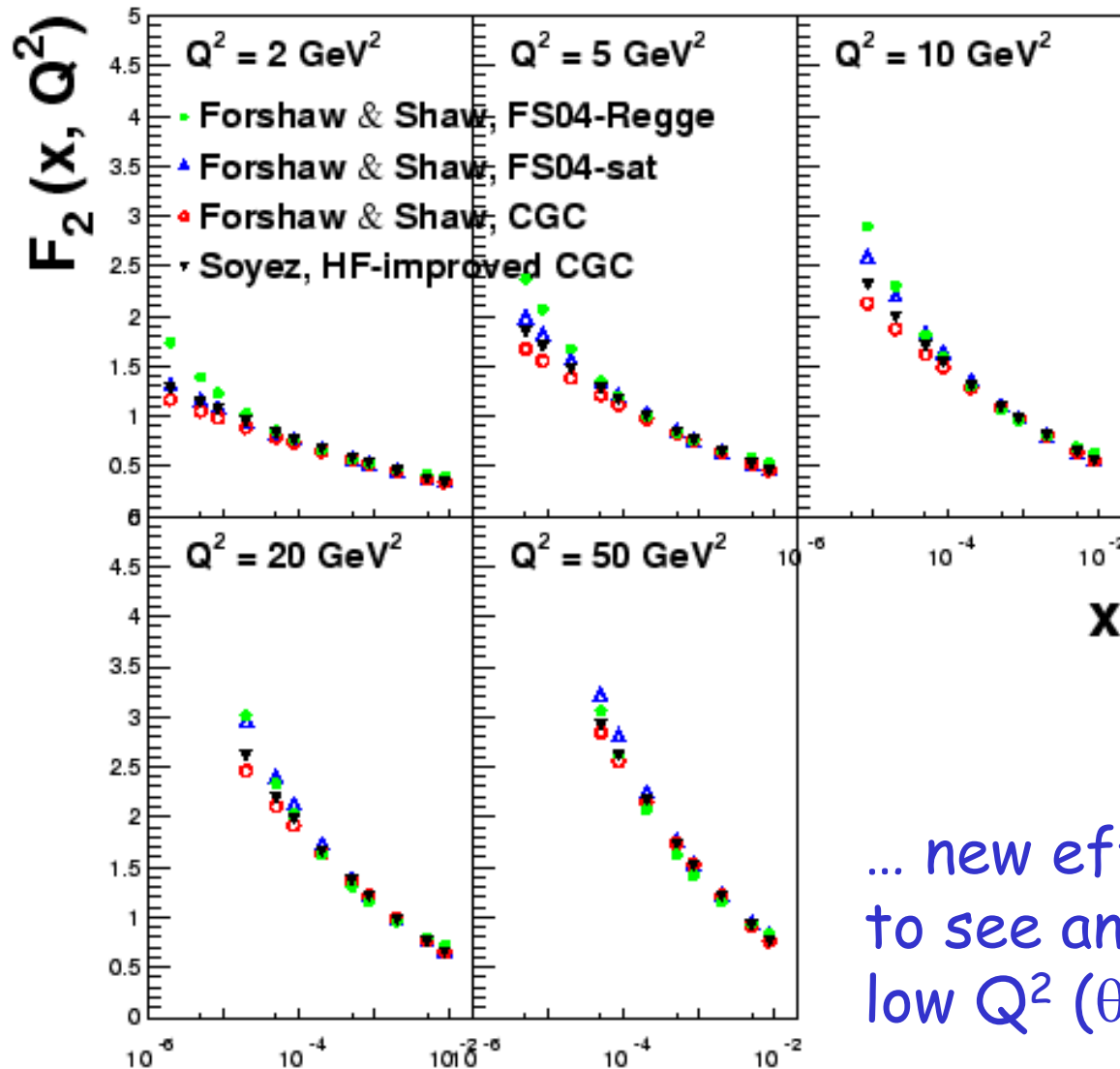

Precise data in LHeC region,  $x > \sim 10^{-6}$

- Extrapolated HERA dipole models ...
- FS04, CGC models including saturation suppressed at low  $x$  &  $Q^2$  relative to non-sat FS04-Regge

... new effects may not be easy to see and will certainly need low  $Q^2$  ( $\theta \rightarrow 179^\circ$ ) region ...

# FL Simulation

Vary proton beam energy as recently done at HERA ?...  
 → example for 1 year ...

$E_p$ (TeV)	Lumi ( $\text{fb}^{-1}$ )
7	1
4	0.8
2	0.2
1	0.05
[0.45	0.01]

... precision typically 5%  
 ... stats limited for  $Q^2 > 1000 \text{ GeV}^2$

... sample lowest x data  
 Compared with 3 dipole models including saturation ...

[Forshaw, Klein, PN, Soyez]

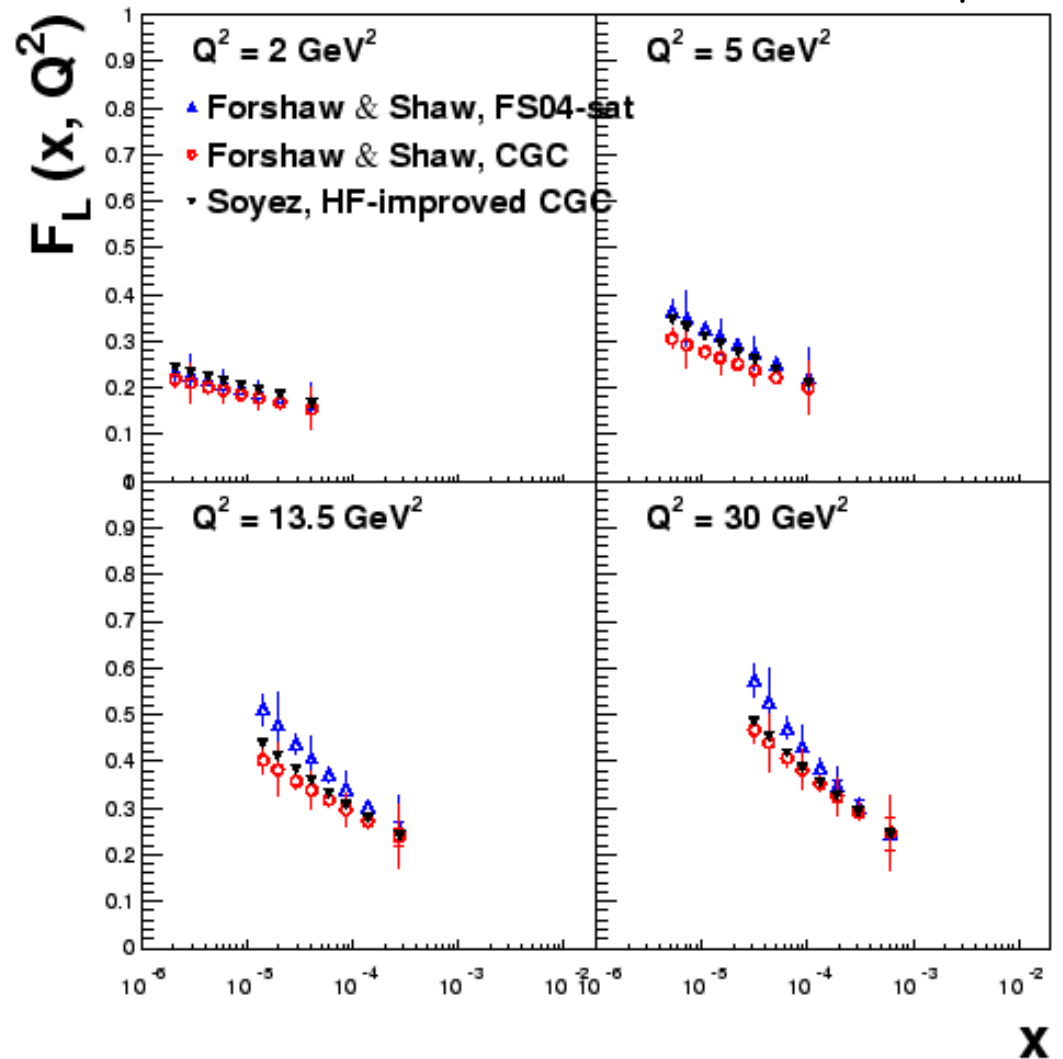

# Can Parton Saturation be Established @ LHeC?

... effects may not be so large in ep  $\rightarrow$  and may be hard to establish unambiguously with  $F_2$  alone  
...  $A^{1/3}$  amplification in gluon in eA ( $\sim 6$  for Pb) may be needed  
... Two first studies using  $F_2$  and  $F_L$  in ep only ...

[Rojo]

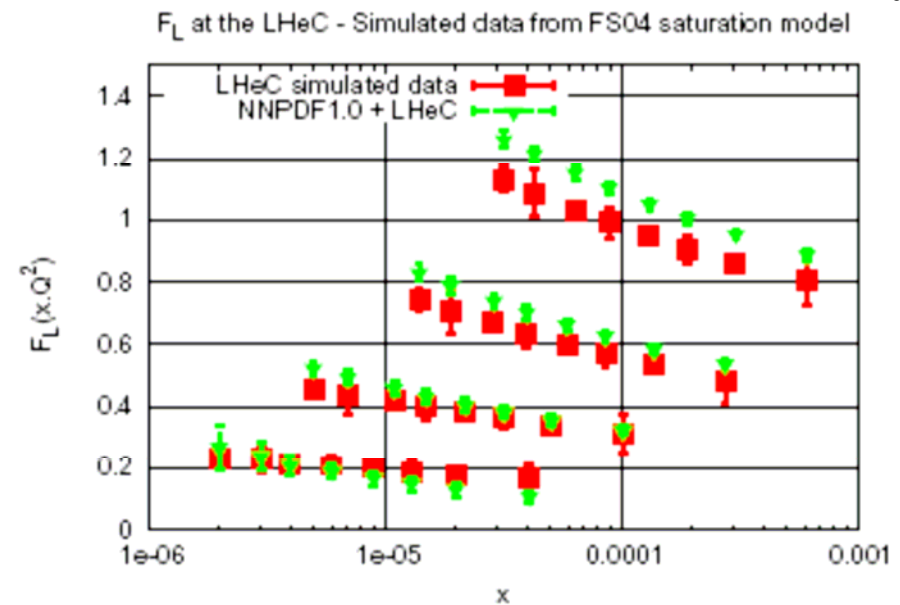
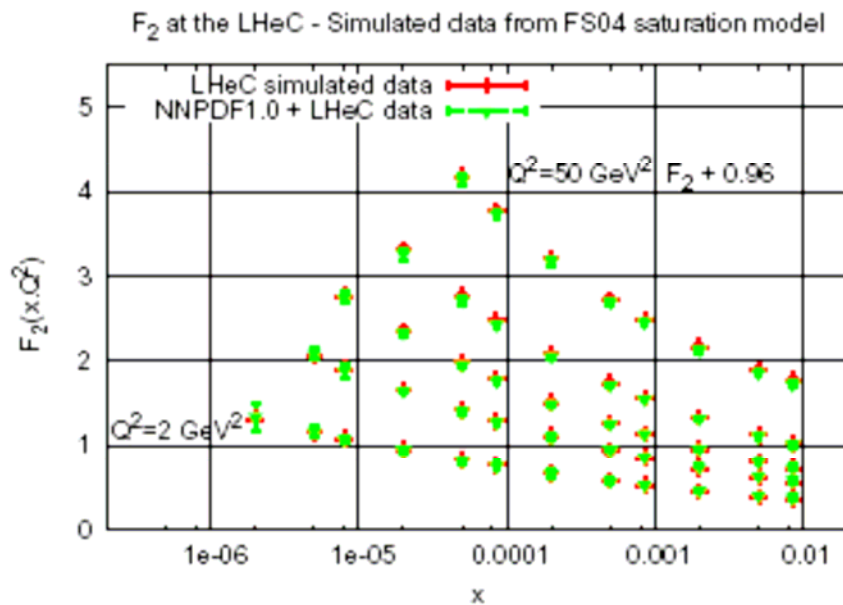

Saturation effects at LHeC (FS04-sat) cannot be absorbed into NNPDF1.0 DGLAP PDF analysis if  $F_2$  and  $F_L$  both fitted

# Can DGLAP adjust to fit LHeC sat models?

[Forshaw, Klein, PN, Perez]

- Attempt to fit ZEUS and LHeC saturation model data in increasingly narrow (low)  $Q^2$  region until good fit obtained
- Use dipole-like (GBW) gluon parameterisation at  $Q_0^2$

$$xg(x, Q_0^2) = A_g \left( 1 - \exp \left[ -B_g \log^2 \left( \frac{x}{x_0} \right)^\lambda \right] \right) (1-x)^{C_g}$$

- Fitting  $F_2$  only, a good fit cannot be obtained beyond the range  $2 < Q^2 < 20 \text{ GeV}^2$
- This fit fails to describe  $F_L$

FS04 dataset,  $F_2$

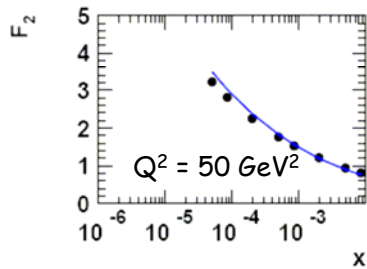
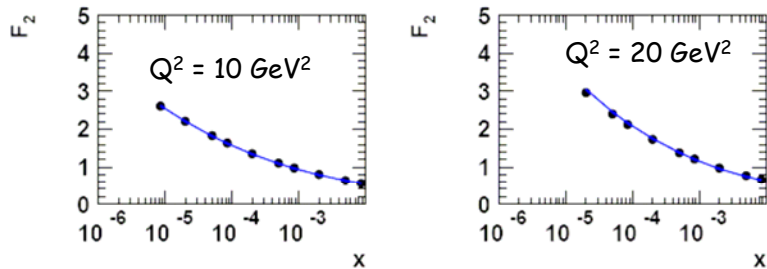
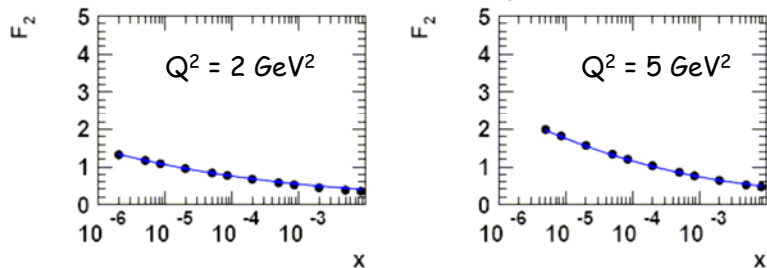

(even faster failure with CGC LHeC pseudo-data)

FS04 dataset,  $F_L$

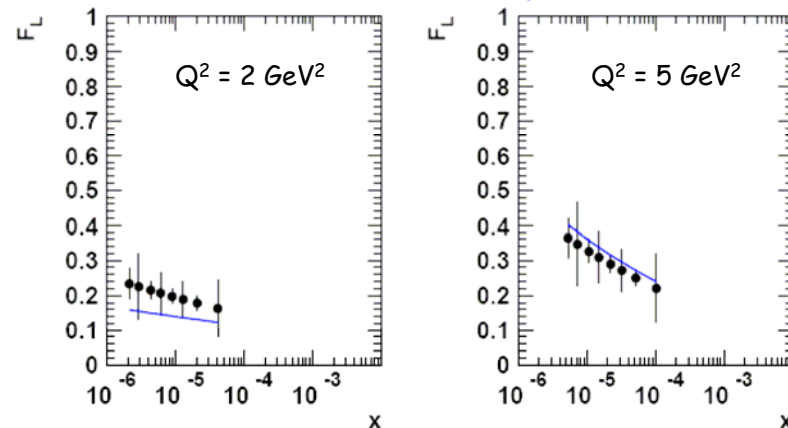



# DVCS at LHeC

(1° acceptance)

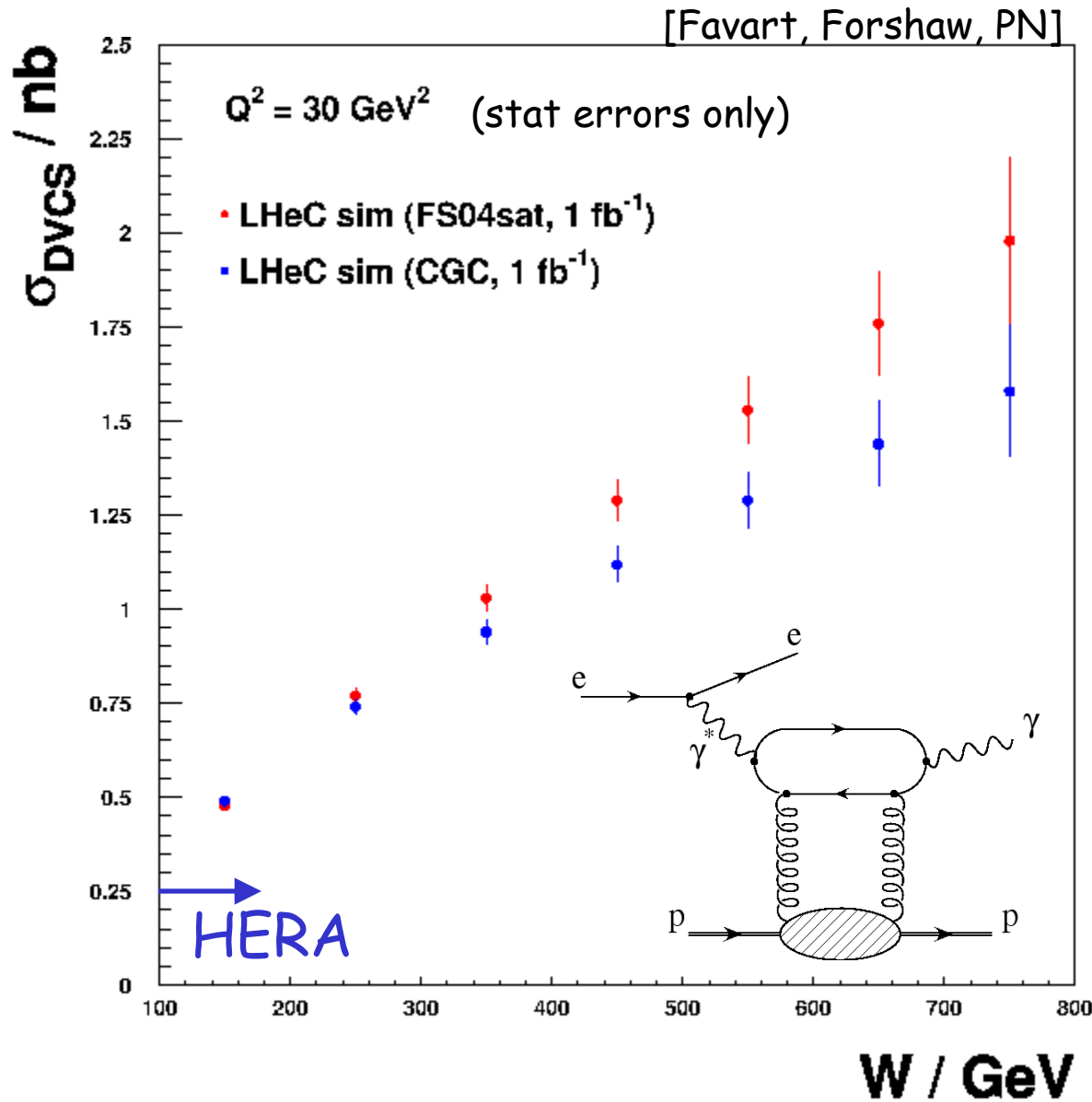

Statistical precision  
with  $1 \text{ fb}^{-1} \sim 2-11\%$

With  $F_2, F_L$ , could  
help establish  
saturation and  
distinguish between  
different models  
which contain it?

Cleaner interpretation  
in terms of GPDs at  
larger LHeC  $Q^2$  values

VMs similar story?...  
No work done so far ☹️

# (Semi)-Inclusive Diffractive DIS

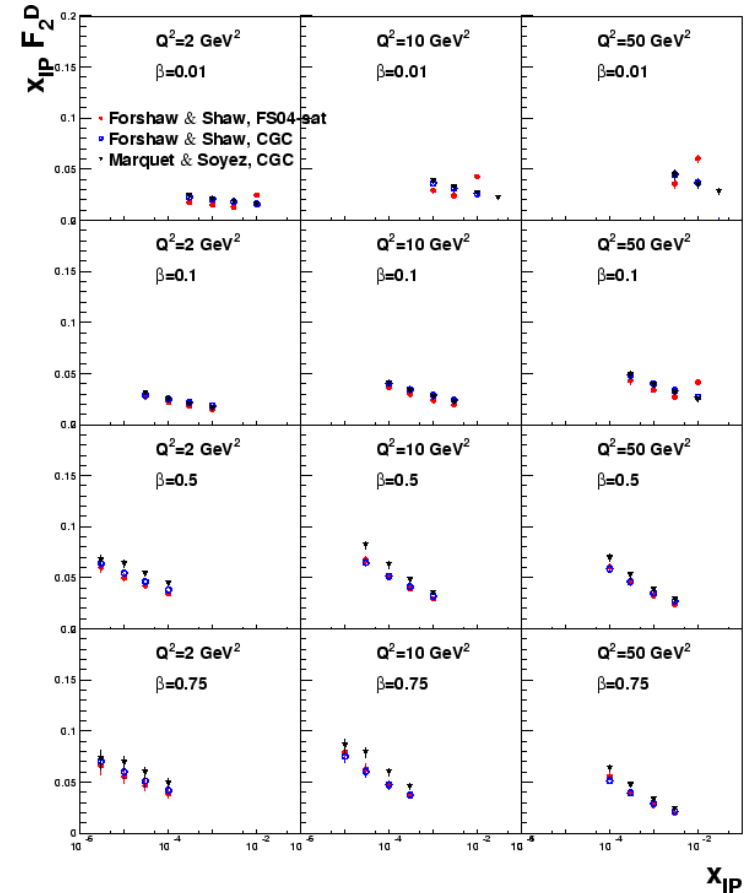
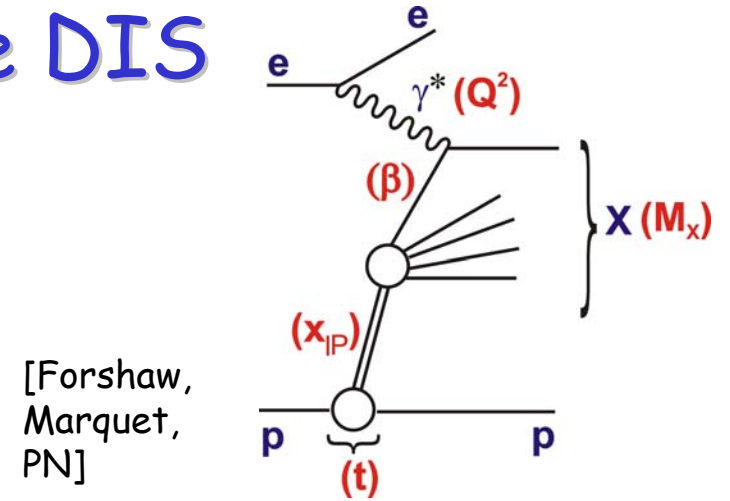
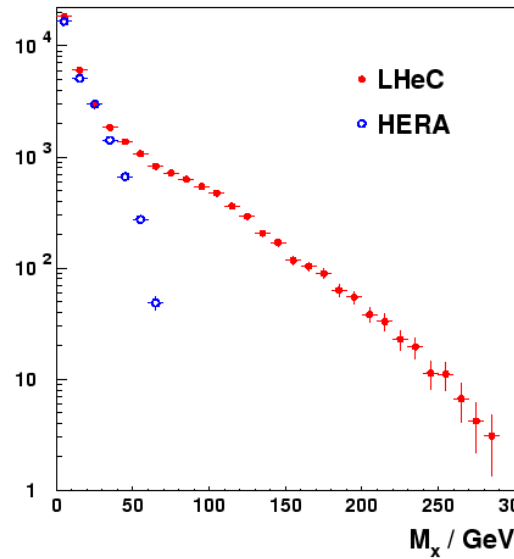
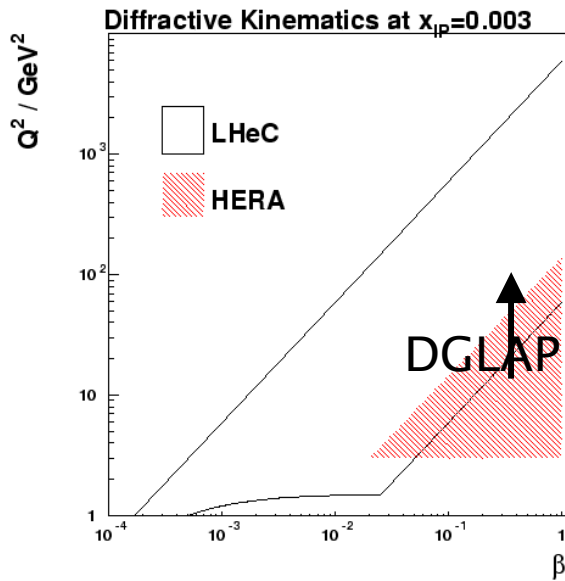

[Studies with  $1^\circ$  acceptance,  $1 \text{ fb}^{-1}$ ]

- 5-10% data, depending on detector
- (D)PDFs / fac'n in much bigger range
- Enhanced parton satn sensitivity?
- $M_x \rightarrow 100 \text{ GeV}$  with  $x_{IP} = 0.01 \dots$   
 $\rightarrow X$  including  $W, Z, b \dots$
- Exclusive production of any  $1^-$  state

# Forward and Diffractive Detectors

- Very forward tracking / calorimetry with good resolution ...
- Proton and neutron spectrometers ...
- Reaching  $x_{IP} = 1 - E_p'/E_p = 0.01$  in diffraction with rapidity gap method requires  $\eta_{max}$  cut around 5 ...forward instrumentation essential!
- Roman pots, FNC should clearly be an integral part.
  - Also for  $t$  measurements
  - Not new at LHC 😊
  - Being considered integrally with interaction region

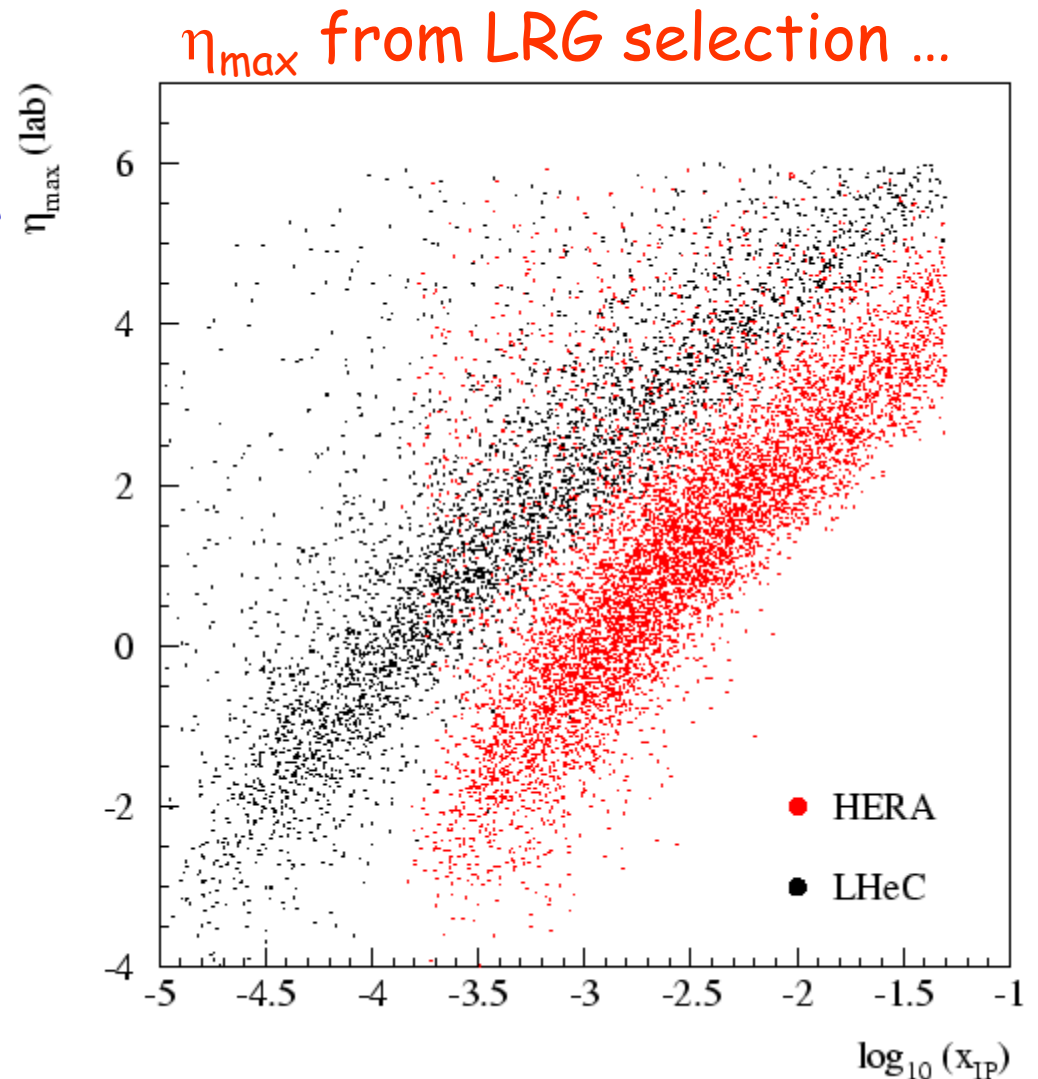

# $\pi$ Structure with Leading Neutrons

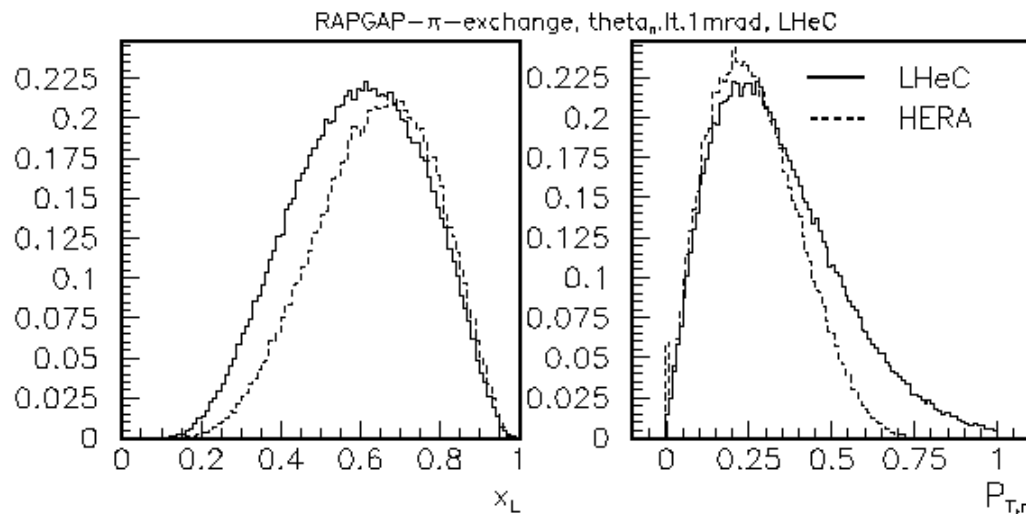

[Bunyatyan]

(RAPGAP  
MC model,  
 $E_p=7\text{TeV}$ ,  
 $E_e=70\text{GeV}$ )

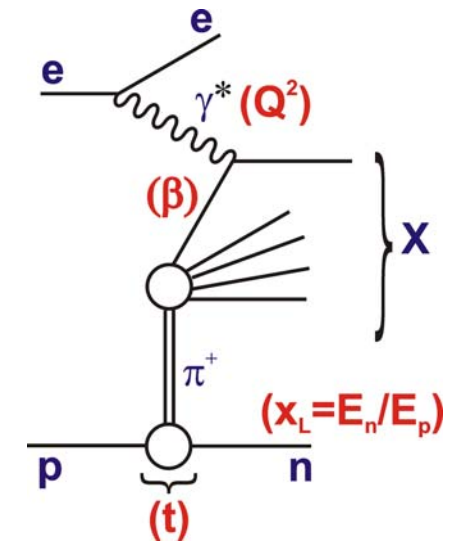

- With  $\theta_n < 1$  mrad, similar  $x_L$  and  $p_T$  ranges to HERA (a bit more  $p_T$  lever-arm for  $\pi$  flux).

- Extensions to lower  $\beta$  and higher  $Q^2$  as in leading proton case.  $\rightarrow F_2^\pi$   
At  $\beta < 5 \cdot 10^{-5}$  (cf HERA reaches  $\beta \sim 10^{-3}$ )

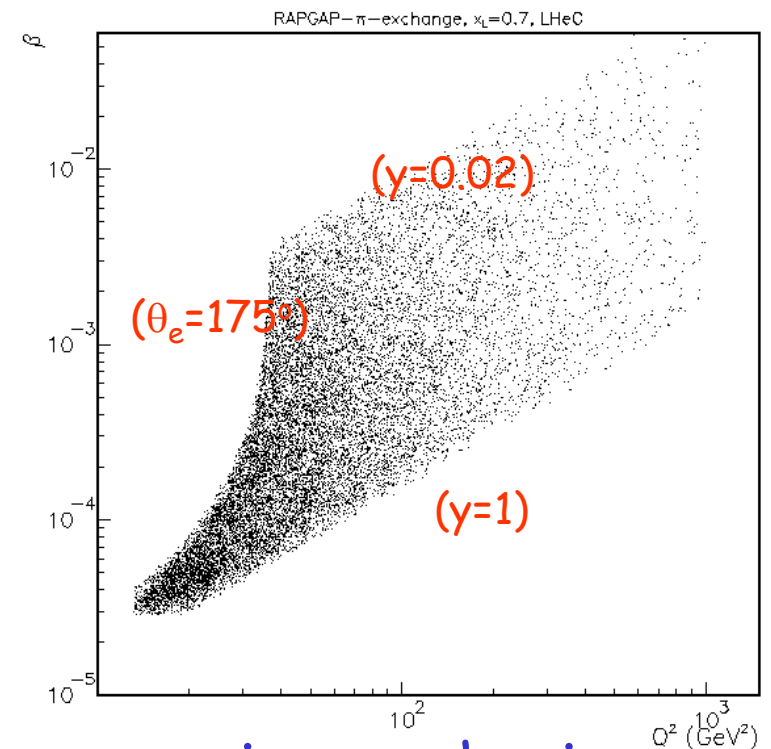

Also relevant to absorptive corrections, cosmic ray physics ...



# With AA at LHC, LHeC is also an eA Collider

- Very limited  $x$  and  $Q^2$  range so far (unknown for  $x < \sim 10^{-2}$ , gluon very poorly constrained)
- LHeC extends kinematic range
- by 3-4 orders of magnitude

... opportunity to extract and understand nuclear parton densities in detail ...

- $\sim A^{1/3}$  enhanced gluon density → additional sat<sup>n</sup> sensitivity
- initial state in AA quark-gluon plasma studies @ LHC / RHIC
- relations between diffraction and shadowing
- Neutron structure & singlet PDF evolution from deuterons

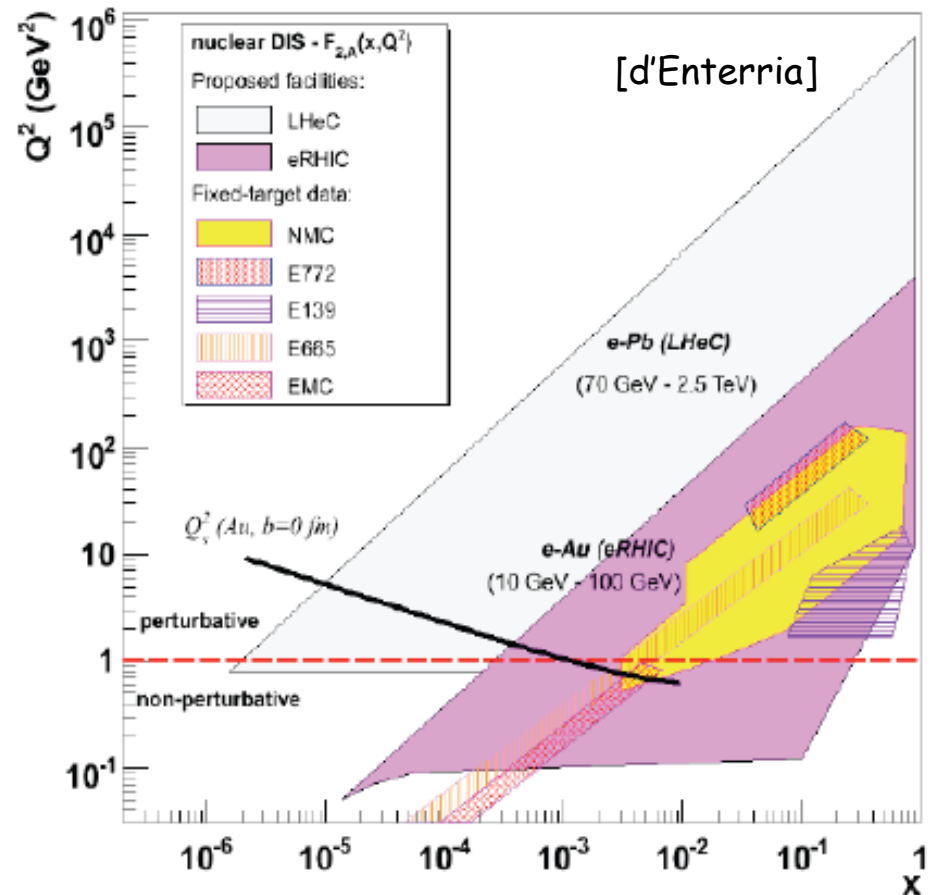

# Machine Considerations and Studies

high  $E_{e,p,A}$ ,  $e^\pm$  polarised, high Luminosity

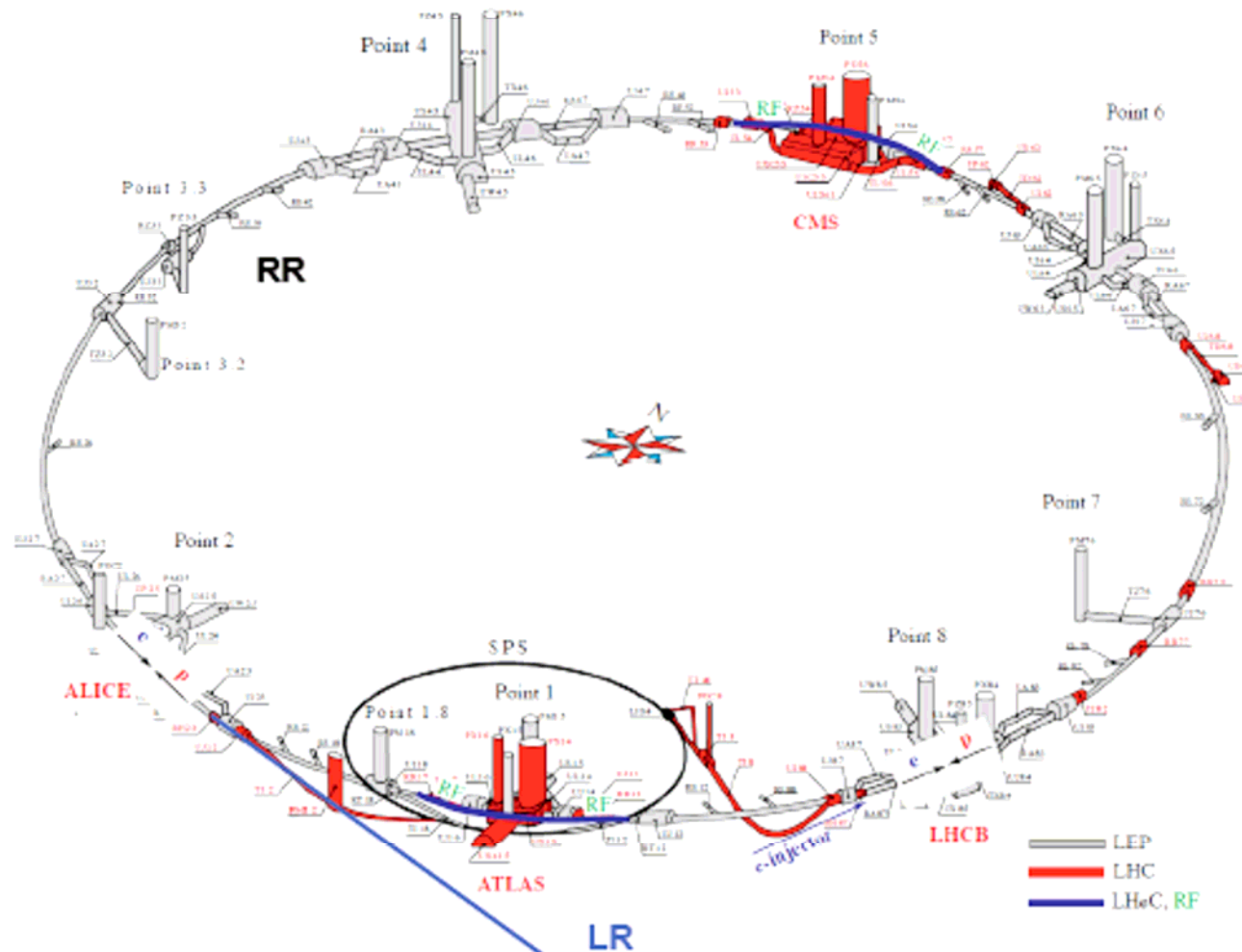

Joint study with CERN, BNL, CI, Jlab, DESY, .. experts

Max Klein LHeC ICFA08

**generalities**

simultaneous ep and pp

power limit set to 100MW

IR at 2 or 8

**p/A:**

SLHC - high intensity p  
(LPA/50ns or ESP/25ns)

Ions: via PS2

new source for deuterons

**e Ring:**

bypasses: 1 and 5  
[use also for rf]

injector: SPL, or dedicated

**e LINAC:**

limited to ~6km (Rhône)  
for IP2, longer for IP8  
CLIC/ILC tunnel.?

# Accelerator Group Summary

[Bruening]

“The discussions at this workshop showed that both options can in principle provide collisions at the TeV scale (e.g. collisions between 60 GeV lepton and 7 TeV proton beams) with a luminosity of  $L = 10^{33} \text{ cm}^{-2} \text{ sec}^{-2}$  in a parasitic mode to the nominal p-p program.”

“The devil lies often in the details and insurmountable problems might only become visible during detailed studies.”

→ “Need to sketch both options for the LHeC in the conceptual design report”

## Ring-Ring

“We have a lot of experience with the design of such a machine (LEP, HERA) and sophisticated tools are at hand for design & performance analysis” [Jowett, Kling]

“By-passes require a minimum of 1.5km tunnelling in the LHC” [Burkhard]

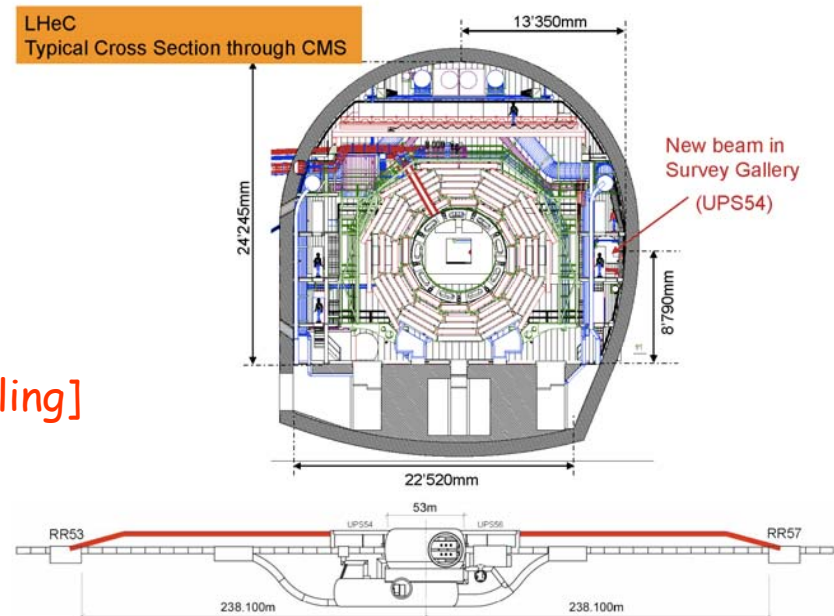

from J.A. Osborne CERN/TS

# Ring-Ring Interaction Region Overview

[Willeke]

- LHC fixes p beam parameters
- 70 GeV electron beam, (compromise energy v synchrotron  $\rightarrow$  50 MW)
- Match e & p beam shapes, sizes
- Fast separation of beams with tolerable synchrotron power requires finite crossing angle
- 2 mrad angle gives  $8\sigma$  separation at first parasitic crossing

... Linac-Ring could get around some of this ... and focusing quadrupoles could be further from IP?

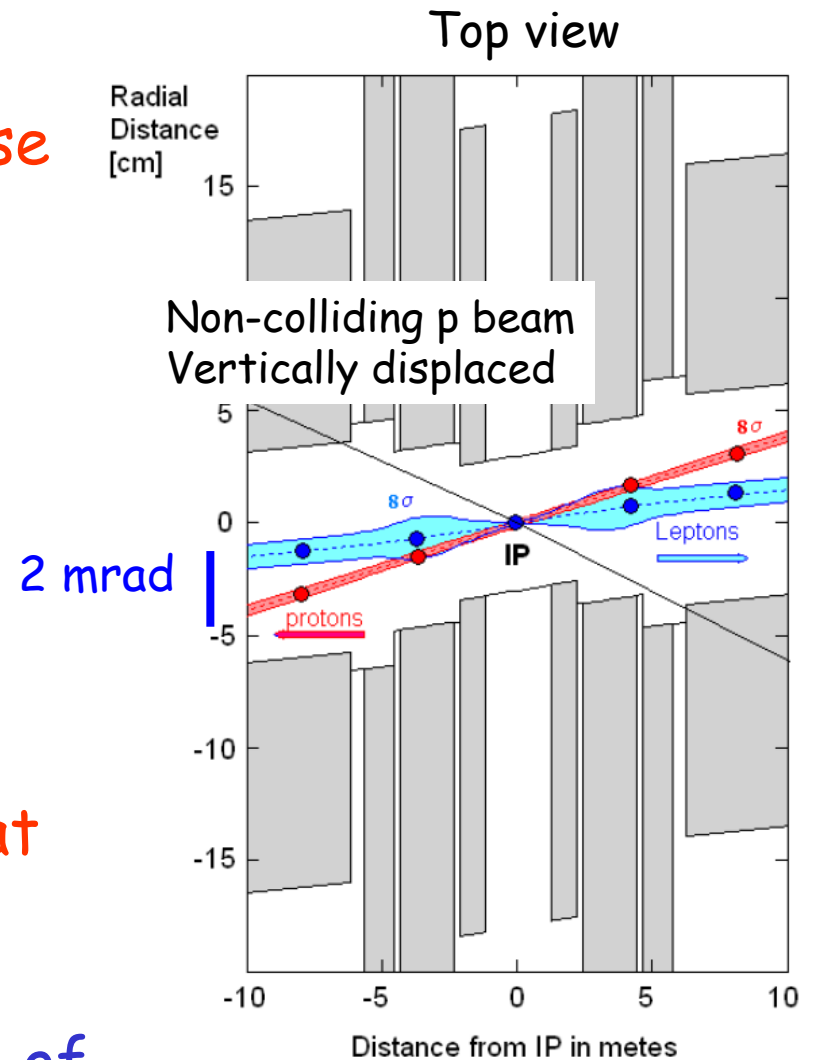



# Thoughts on Linac-Ring Layout Designs

[Zimmermann]

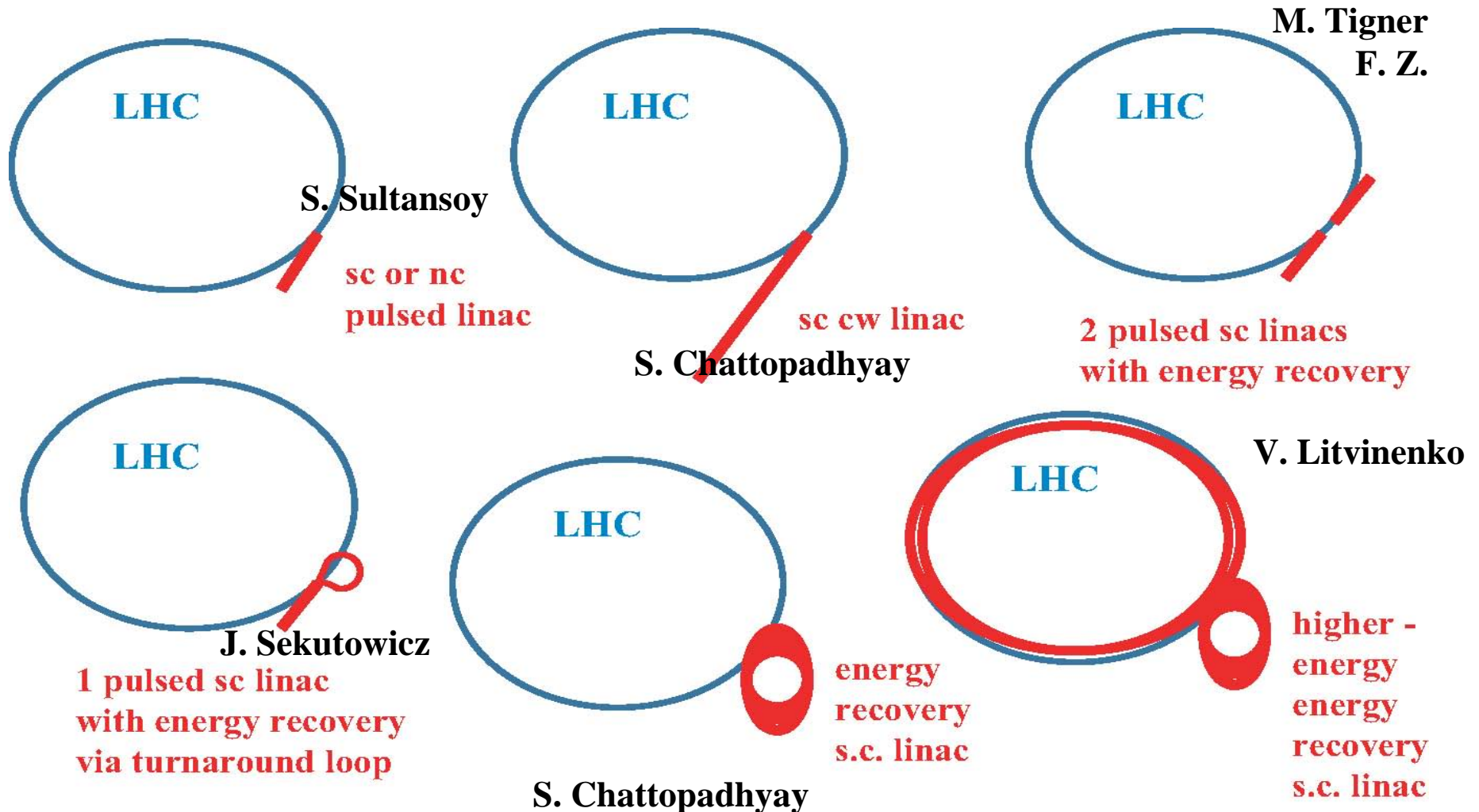

... lots of R&D required ...

# Another idea: electrons in the SPL?

SPL (Superconducting Proton Linac) is part of proposed CERN p-accelerator upgrade programme.  
... could be used to provide up to **20 GeV electrons** (4 passes of 5 GeV)

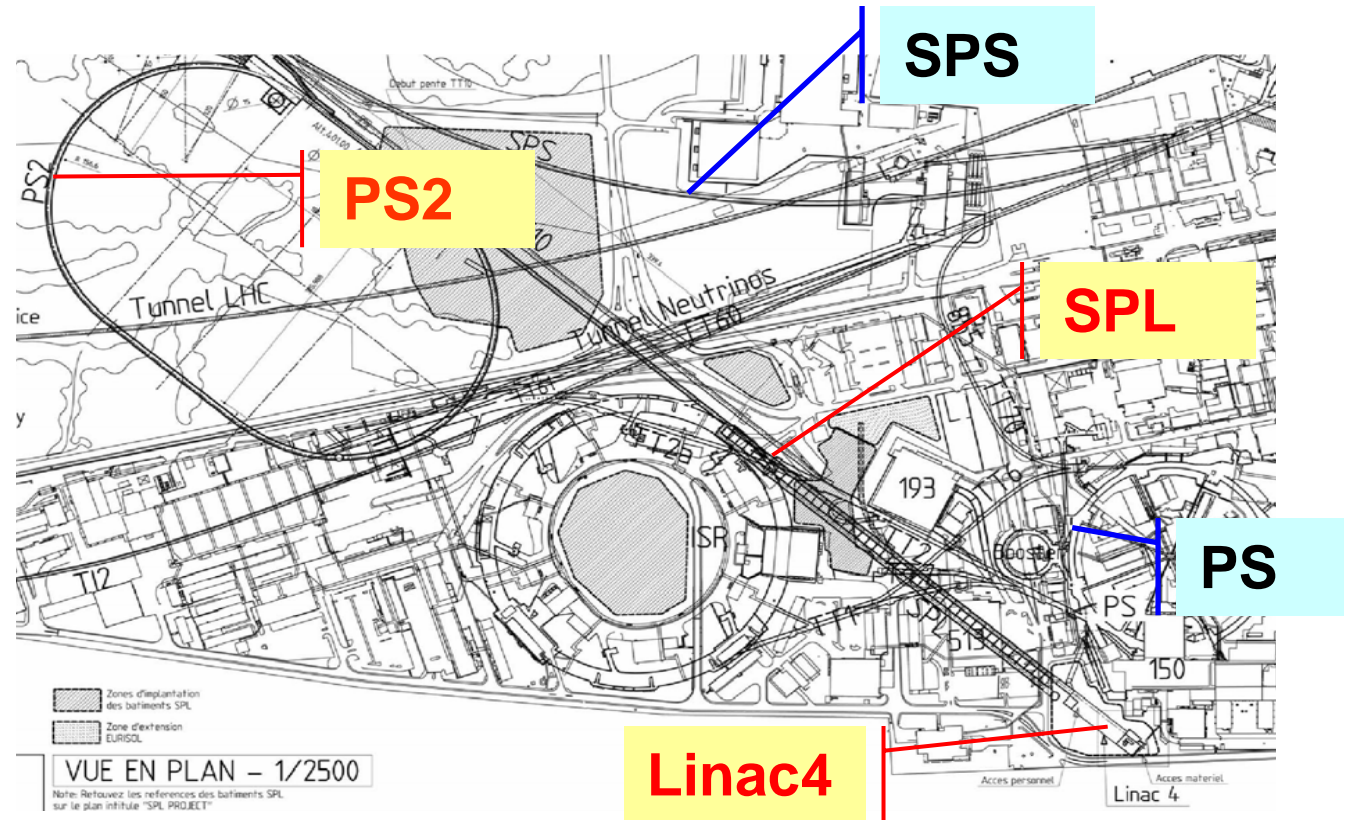
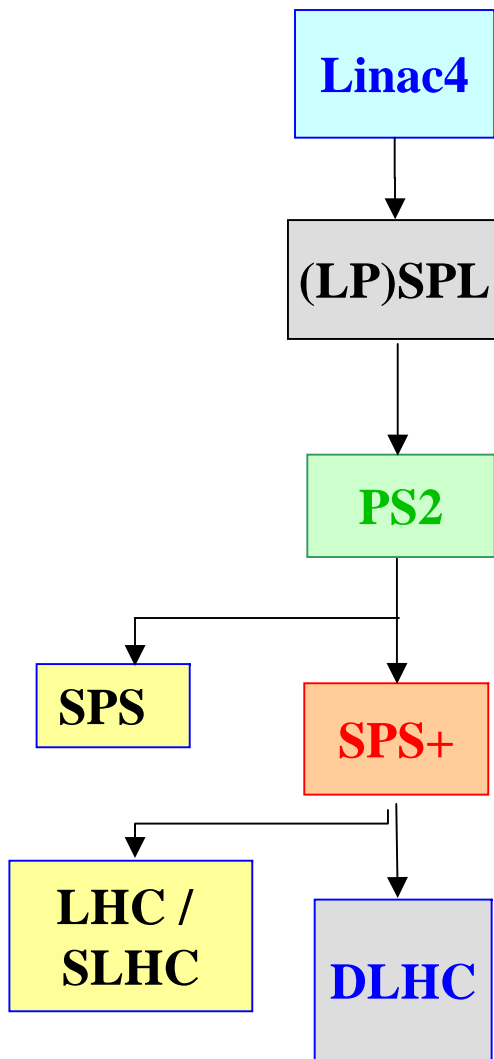

# First Detector Concepts

Muon chambers  
(fwd,bwd,central)

Coil (r=3m l=8.5m, 2T)

[Return Fe not drawn]

**Central Detector**

Hadronic Calo (Fe/LAr)

El.magn. Calo (Pb,Sc)

GOSSIP (fwd+central)

[Gas on Slimmed Si Pixels]  
[0.6m radius for 0.05% \* pt in 2T field]

Pixels

Elliptic beam pipe (~3cm)

**Fwd Spectrometer**  
(down to 1°)

**Tracker**

Calice (W/Si)

FwdHadrCalo

**Bwd Spectrometer**  
(down to 179°)

**Tracker**

Spacal (elm, hadr)

Max Klein LHeC ICFA08

## L1 Detector: version for low x Physics

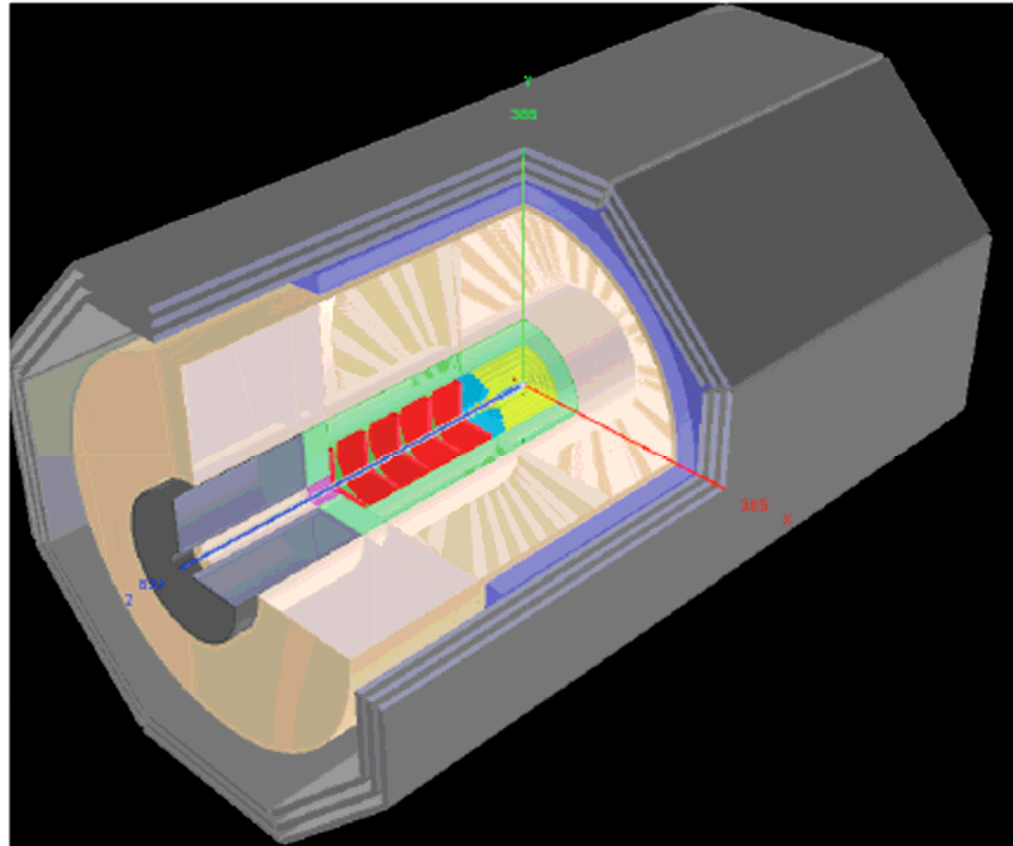

To be extended further in fwd direction. Tag p,n,d. Also e, $\gamma$  (bwd)

# First Detector Concepts

## L1 Detector: version for hiQ<sup>2</sup> Physics

Muon chambers  
(fwd,bwd,central)

Coil (r=3m l=8.5m, 2T)

**Central Detector**

Hadronic Calo (Fe/LAr)

El.magn. Calo (Pb,Sc)

GOSSIP (fwd+central)

Pixels

Elliptic pipe (~3cm)

**Fwd Calorimeter  
(down to 10°)**

Lepton low  $\beta$  magnets

FwdHadrCalo

**Bwd Spectrometer  
(down to 170°)**

Lepton low  $\beta$  magnets

Spacal (elm, hadr)

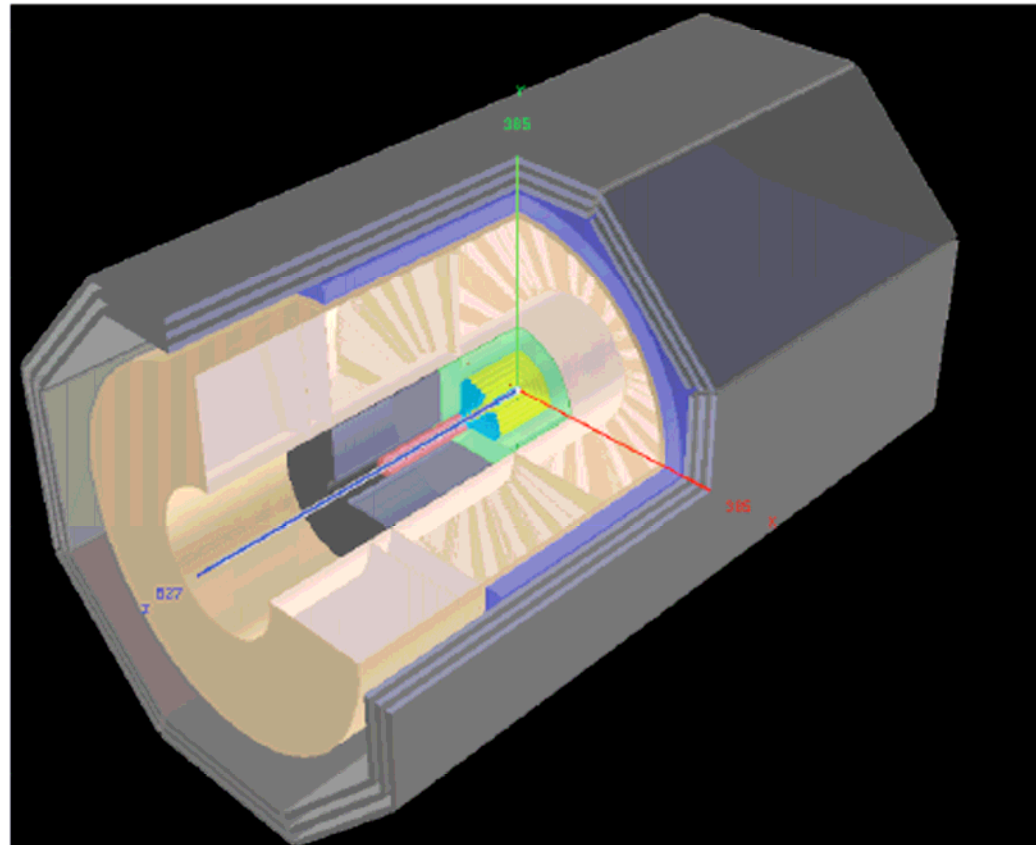

- 2 interaction points / experiments?
- 2 phases of single experiment (a la HERA)?
- Other ideas



# Developing a Combined Function "Magcal"?

[Greenshaw]

- Helium cooled SC magnet.
- Coils in He bath.

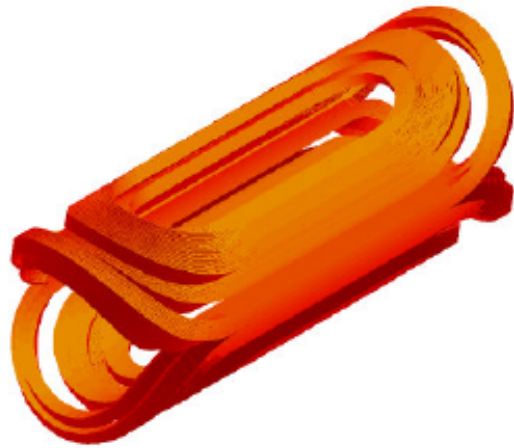

- Space for calorimeter using He as active component?

- Could add stainless steel plates as absorber with readout pads:

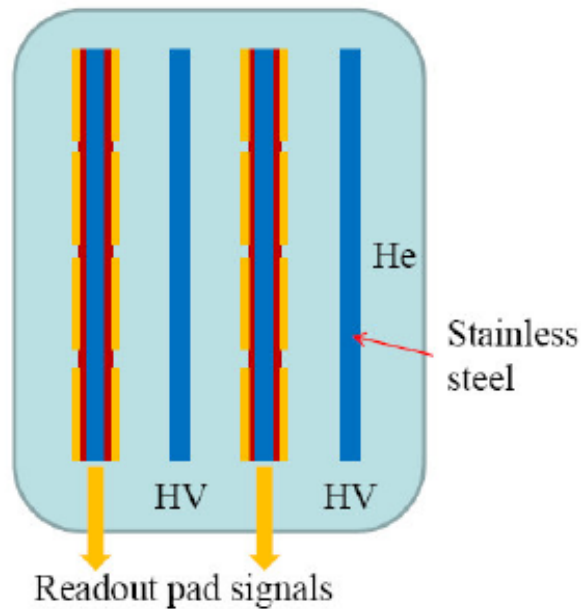

Use scintillation of liquid He to get signal?...

... Calo is all edges!...

→ What sort of resolution is achievable?

→ What is influence on final beam focus?

→ ...?

... also potentially interesting for SLHC and elsewhere?

... could even think of doing the same with solenoids / toroids?

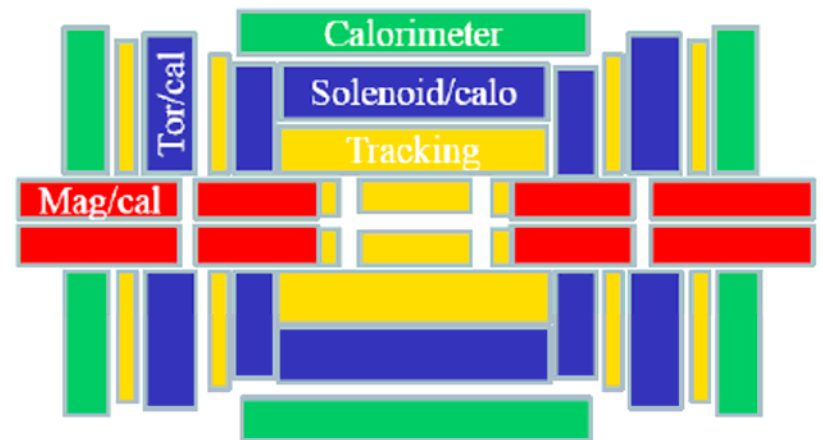



# Summary

- LHC is a totally new world of energy and luminosity! LHeC proposal aims to exploit this for TeV lepton-hadron scattering
  - ep complementing next generation pp, ee facilities
- First ECFA/CERN workshop successfully gathered accelerator, theory & experimental colleagues
  - First debates on machine and detector layout
  - First (often crude) tasters of physics
  - Many uncovered topics (eA, VM, pots,  $\gamma p$  ...)
- Further meetings planned for April '09 and September '09
  - Conceptual Design Report by early 2010
  - Input to CERN strategy document mid 2010
  - UK seedcorn funding request in near future
- All ideas and involvement welcome!

[More at [www.lhec.org.uk](http://www.lhec.org.uk)]

Back-Ups Follow

# Jets and Heavy Flavours

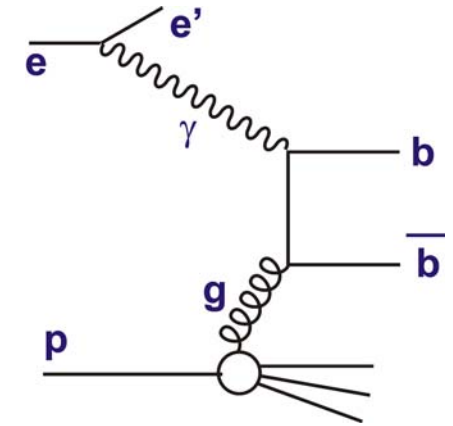
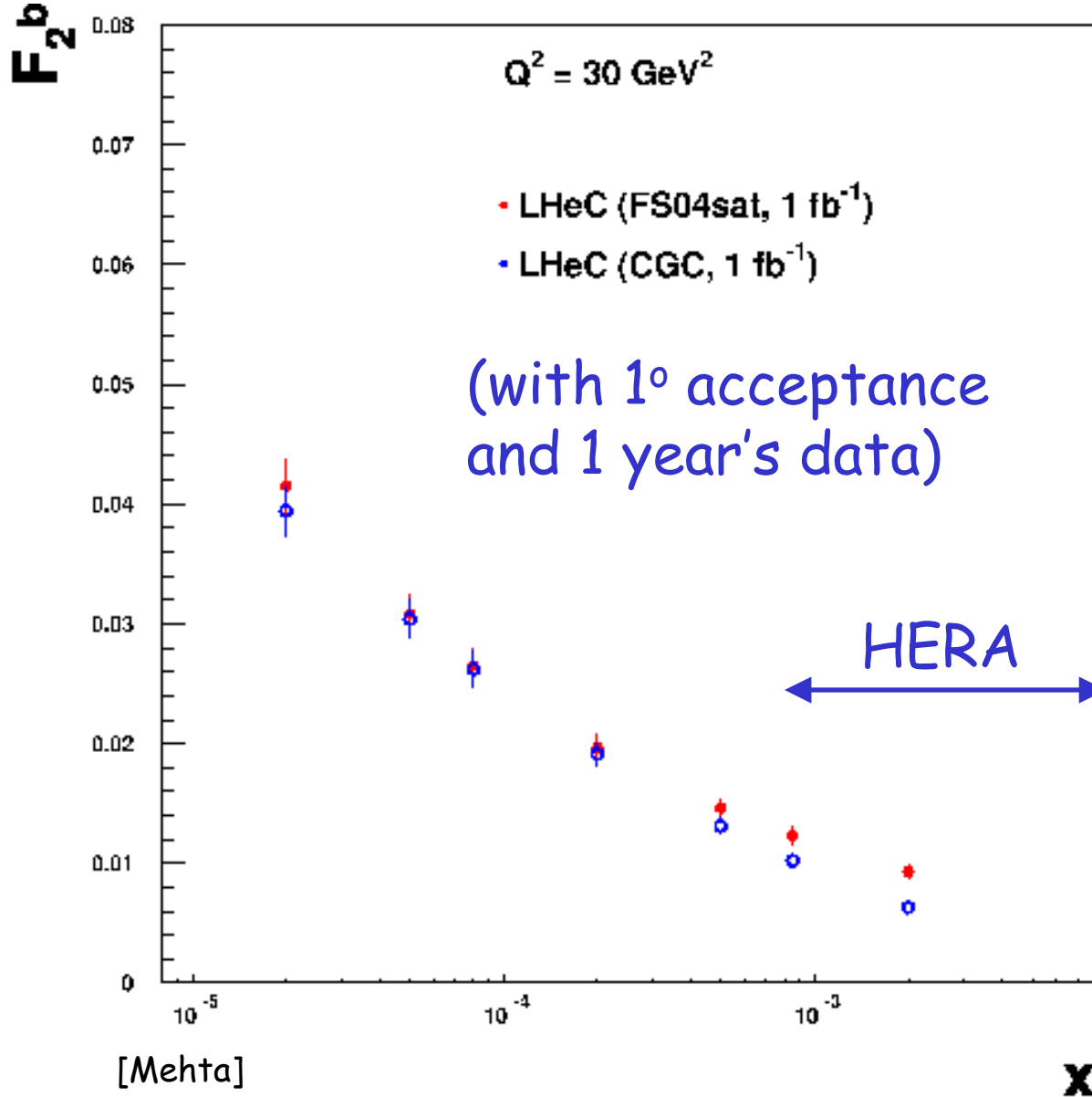

Constrain gluon (at Remarkably low  $x$ !) through jets and heavy flavour measurements

e.g.  $F_2^b$  to a few % constraining gluon down to  $x \sim 2 \cdot 10^{-5}$ .

# Heavy Quarks: HERA $\rightarrow$ LHC

- HERA HF information limited by kinematic range and lumi (reasonable charm, some beauty, almost no strange)
- Crucial for understanding LHC initial state for new processes (e.g.  $b\bar{b} \rightarrow H$ ) and backgrounds.

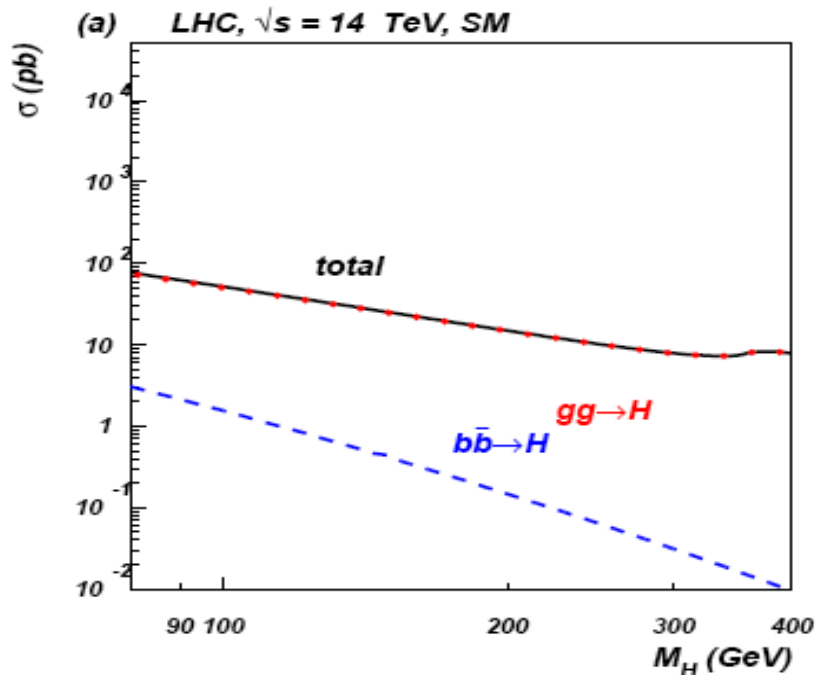

Higgs

<-SM

MSSM- $\rightarrow$

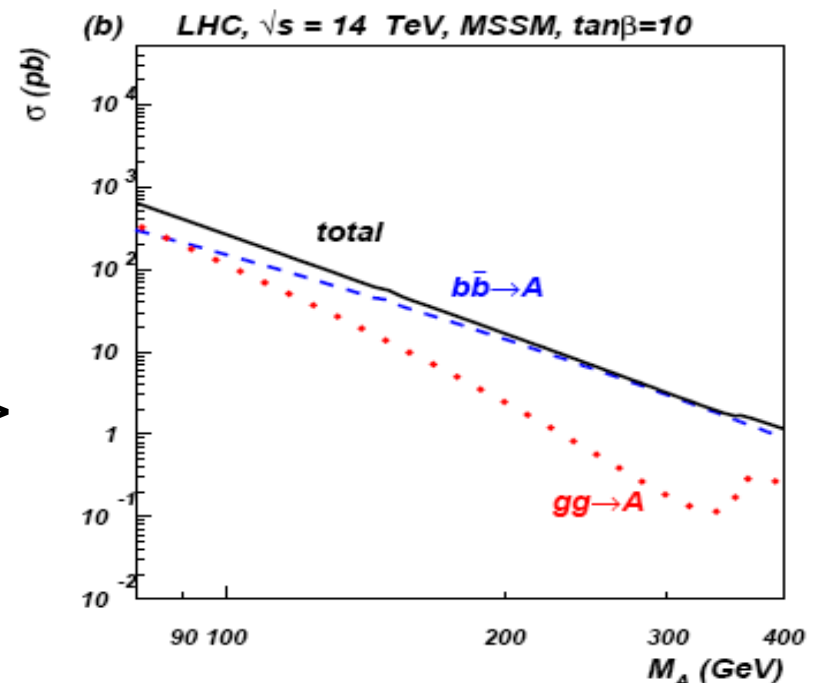

- LHC predictions rely strongly on extrapolations and pQCD (e.g. CTEQ: 7% effect on  $W, Z$  rates varying HF treatment).

# DVCS Measurement

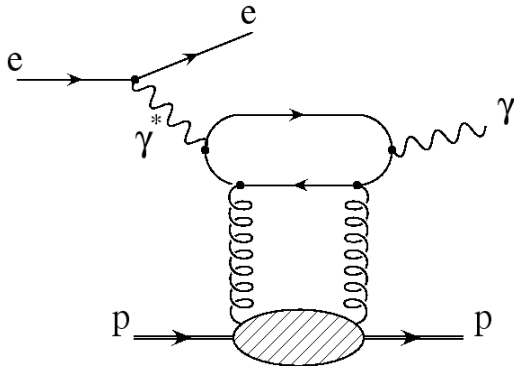

... the classic approach to 'generalised parton densities' (GPDs)

... can be tackled as at HERA through inclusive selection of  $ep \rightarrow e\gamma$  and statistical subtraction of Bethe-Heitler background

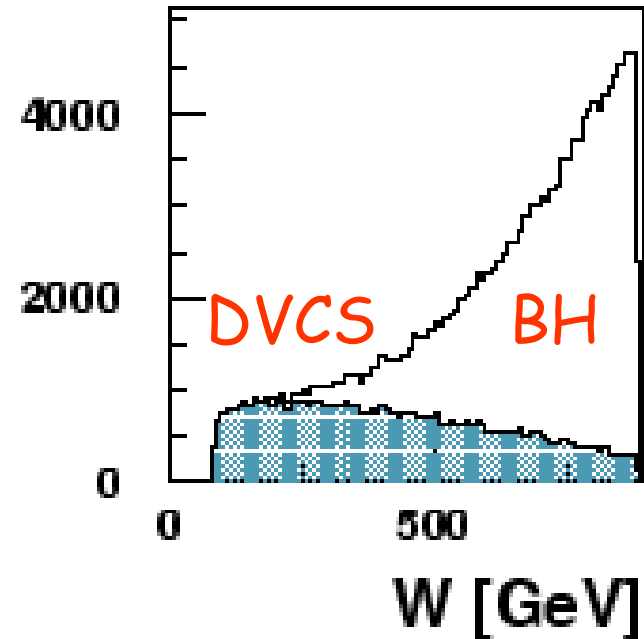
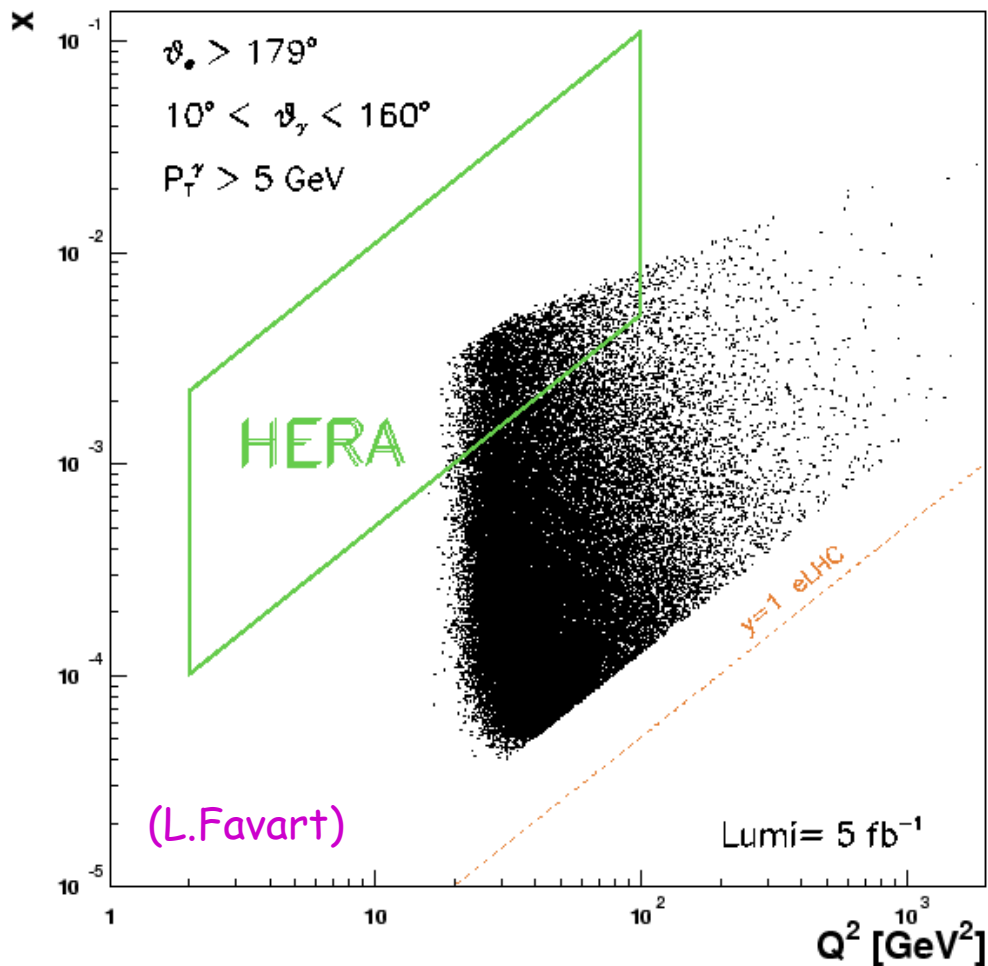



# Linac-Ring Design

- 140 GeV electron beam at 23 MV/m is 6km + gaps
- CMS energy  $\rightarrow$  2 TeV!

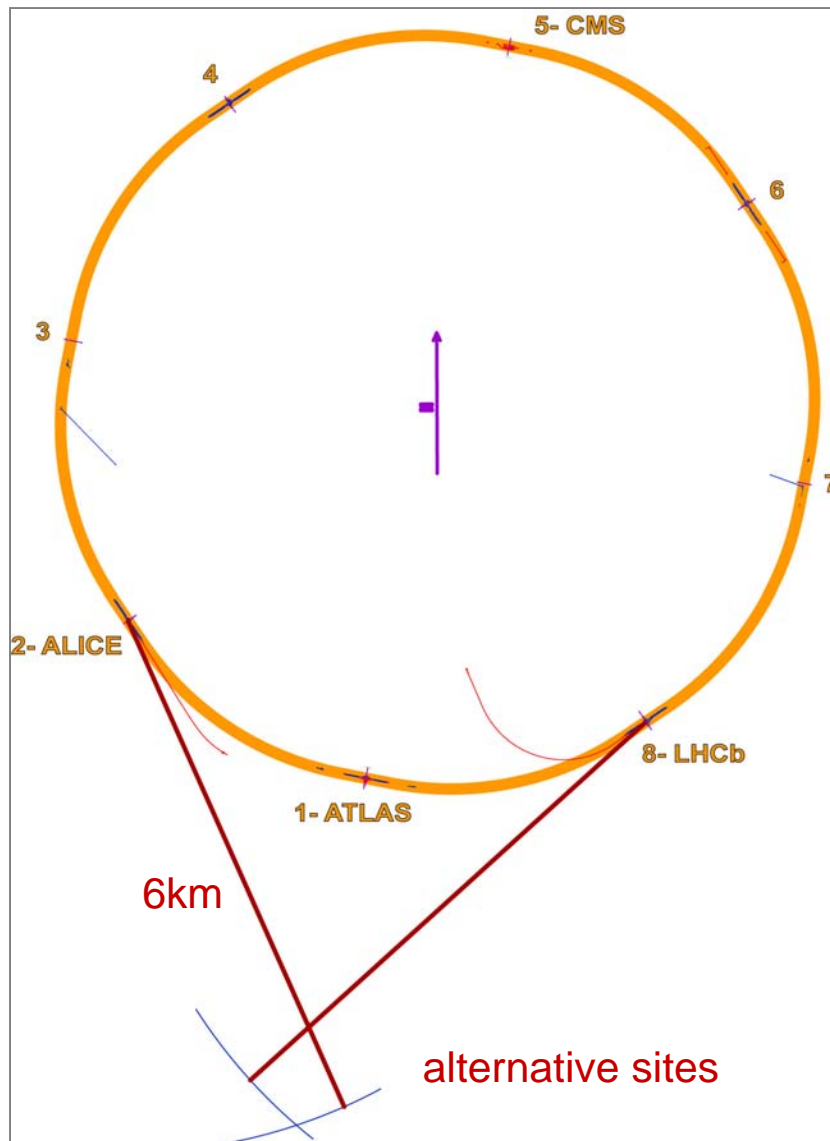

	units	ring-linac pulsed		ring-linac, cw , ~99% energy recovery	
		e-	p	e-	p
energy	GeV	70	7000	70	7000
punch population	$10^{10}$	2	17	2	17
$\sigma_z$	cm	0.03	7.55	0.03	7.55
beam current (pulsed)	mA	101	858	101	858
emittance $\epsilon_{x,y}$	nm	0.5, 0.5			
$\beta^*_{x,y}$	cm	15, 15			
spacing	ns	25			
e-linac/ring length	km	3.5		7 (2 linacs)	
e- pulse length		1 ms		cw	
repetition rate		5 Hz		continuous	
e- beam power	MW	35		7000	
peak luminosity	$10^{32} \text{ cm}^{-2} \text{ s}^{-1}$	0.6		2x110	

S. Chattopadhyay (Cockcroft), F.Zimmermann (CERN), et al.

Relatively low peak lumi, but good average lumi  
 Energy recovery (2 linacs?) ...else prohibitive power usage?

# Luminosity: Ring-Ring

$$L = \frac{N_p \gamma}{4 \pi e \varepsilon_{pn}} \cdot \frac{I_e}{\sqrt{\beta_{px} \beta_{py}}} = 8.310^{32} \cdot \frac{I_e}{50 \text{ mA}} \frac{m}{\sqrt{\beta_{px} \beta_{pn}}} \text{ cm}^{-2} \text{ s}^{-1}$$

$$\begin{aligned} \varepsilon_{pn} &= 3.8 \mu\text{m} \\ N_p &= 1.7 \cdot 10^{11} \\ \sigma_{p(x,y)} &= \sigma_{e(x,y)} \\ \beta_{px} &= 1.8 \text{ m} \\ \beta_{py} &= 0.5 \text{ m} \end{aligned}$$

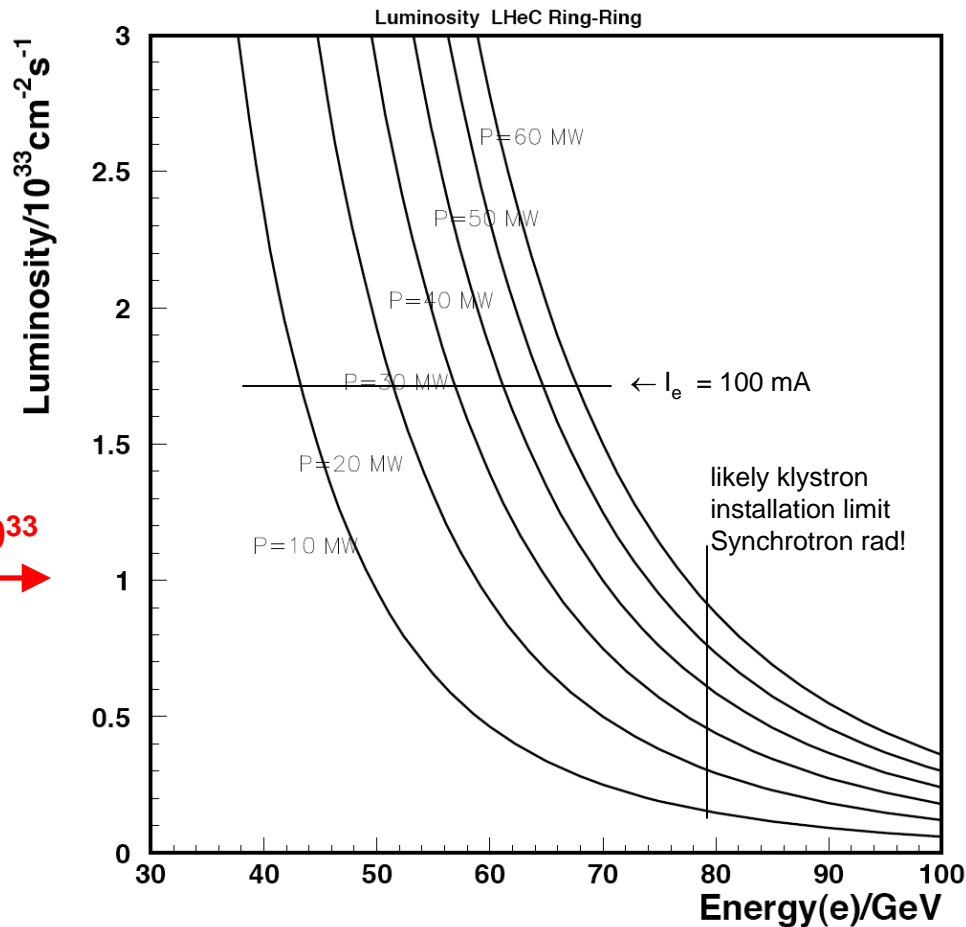

$$I_e = 0.35 \text{ mA} \cdot \frac{P}{\text{MW}} \cdot \left( \frac{100 \text{ GeV}}{E_e} \right)^4$$

**$10^{33}$  can be reached in RR**  
 $E_e = 40\text{-}80 \text{ GeV}$  &  $P = 5\text{-}60 \text{ MW}$ .

HERA was  $1\text{-}4 \cdot 10^{31} \text{ cm}^{-2} \text{ s}^{-1}$   
 huge gain with SLHC p beam

F.Willeke in hep-ex/0603016:  
 Design of interaction region  
 for  $10^{33}$  : 50 MW, 70 GeV

May reach  $10^{34}$  with ERL in  
 bypasses, or/and reduce power.  
 R&D performed at BNL/eRHIC

# Luminosity: Linac-Ring

$$L = \frac{N_p \gamma}{4\pi e \varepsilon_{pn} \beta^*} \cdot \frac{P}{E_e} = 1 \cdot 10^{32} \cdot \frac{P / MW}{E_e / GeV} cm^{-2} s^{-1}$$

$$\begin{aligned} \varepsilon_{pn} &= 3.8 \mu m \\ N_p &= 1.7 \cdot 10^{11} \\ \beta^* &= 0.15 m \end{aligned}$$

$$I_e = 100 mA \cdot \frac{P}{MW} \cdot \frac{GeV}{E_e}$$

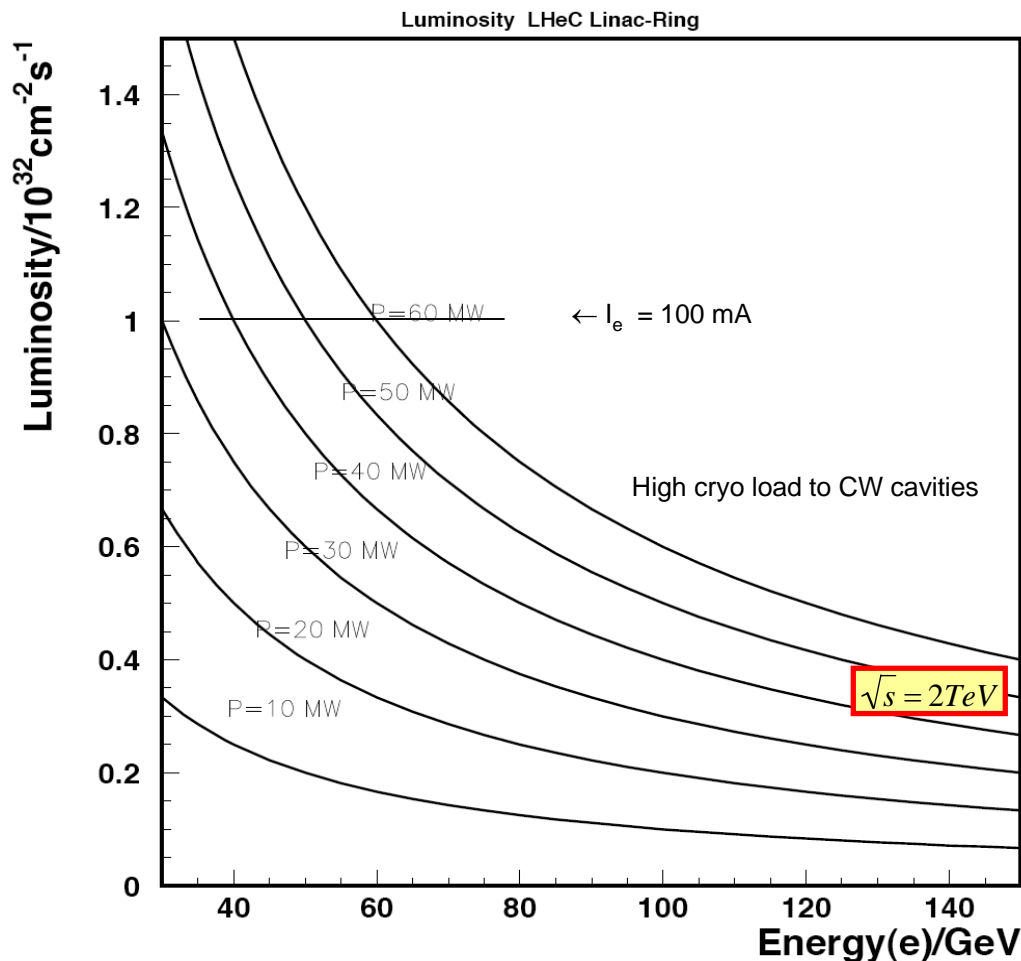

LHeC as Linac-Ring version  
can be as luminous as HERA II:

**$4 \cdot 10^{31}$  can be reached with LR:**  
 $E_e = 40-140$  GeV &  $P=20-60$  MW  
 LR: average lumi close to peak

140 GeV at 23 MV/m is 6km +gaps

Luminosity horizon: high power:  
 ERL (2 Linacs?)

# Overview of LHeC Parameters

Table 3: *Main Parameters of the Lepton-Proton Collider*

Property	Unit	Leptons	Protons
Beam Energies	GeV	70	7000
Total Beam Current	mA	74	544
Number of Particles / bunch	$10^{10}$	1.04	17.0
Horizontal Beam Emittance	nm	7.6	0.501
Vertical Beam Emittance	nm	3.8	0.501
Horizontal $\beta$ -functions at IP	cm	12.7	180
Vertical $\beta$ -function at the IP	cm	7.1	50
Energy loss per turn	GeV	0.707	$6 \cdot 10^{-6}$
Radiated Energy	MW	50	0.003
Bunch frequency / bunch spacing	MHz / ns	40 / 25	
Center of Mass Energy	GeV	1400	
Luminosity	$10^{33} \text{cm}^{-2} \text{s}^{-1}$	1.1	

# Geometric Scaling at the LHeC

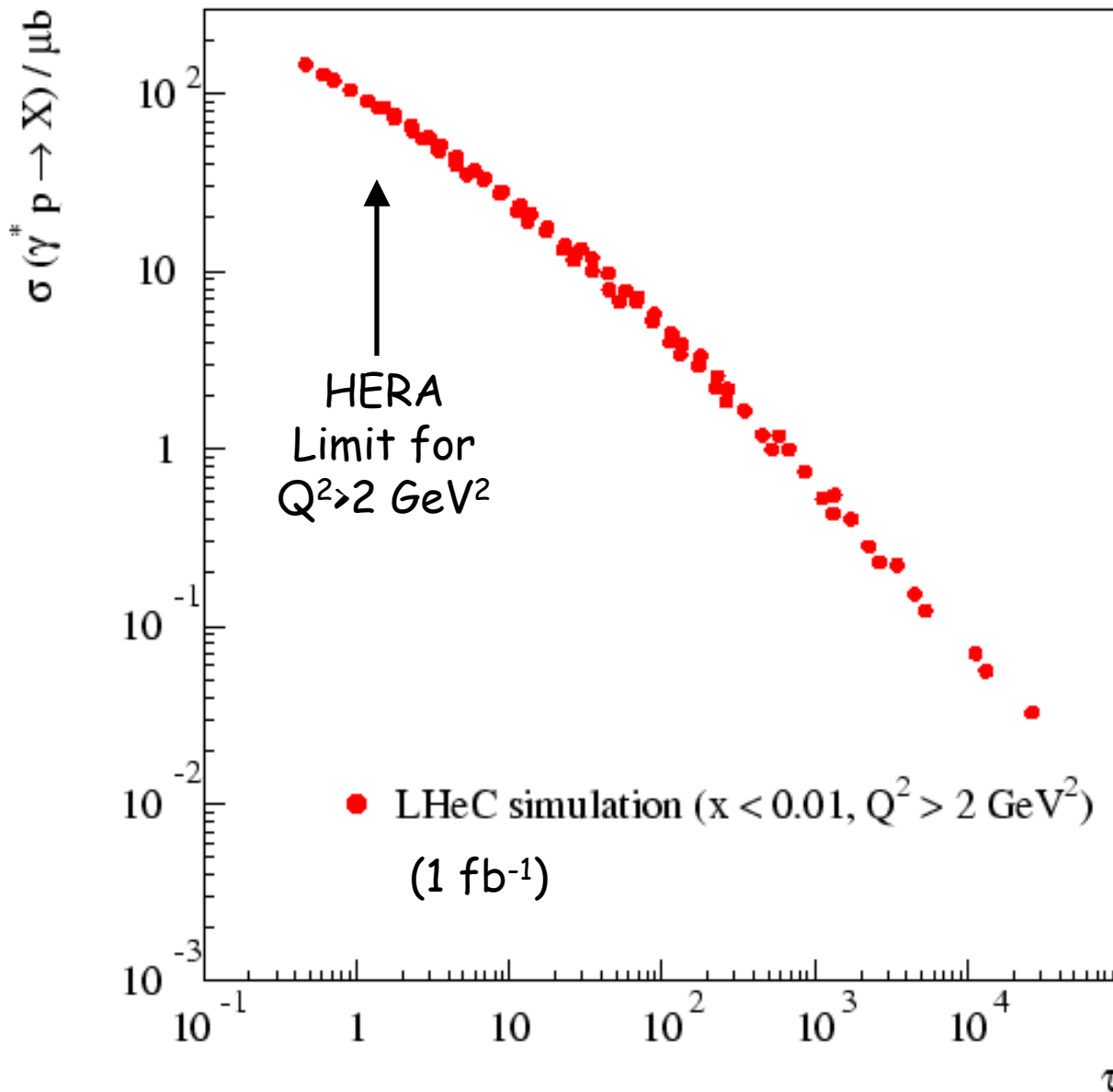

LHeC reaches  
 $\tau \sim 0.15$  for  
 $Q^2 = 1 \text{ GeV}^2$  and  
 $\tau \sim 0.4$  for  
 $Q^2 = 2 \text{ GeV}^2$

Some (though  
limited) acceptance  
for  $Q^2 < Q_s^2$  with  $Q^2$   
"perturbative"

Could be enhanced  
with nuclei.

$Q^2 < 1 \text{ GeV}^2$  accessible  
in special runs?



# Reminder : Dipole models

- Unified description of low  $x$  region, including region where  $Q^2$  small and partons not appropriate degrees of freedom ...

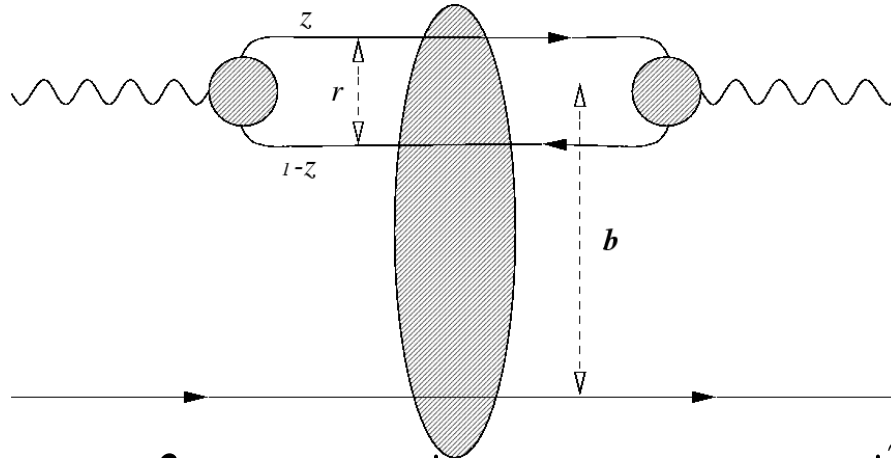

$$\sigma_{\gamma^* p}^{T,L}(x, Q^2) \sim \int dz d^2 r \left| \psi_{\gamma^*}^{T,L}(z, r, Q^2) \right|^2 \sigma_{dipole}(x, r, z)$$

- Simple unified picture of many inclusive and exclusive processes ... strong interaction physics in (universal) dipole cross section  $\sigma_{dipole}$ . Process dependence in wavefunction  $\Psi$  Factors

- $q\bar{q}$ -g dipoles also needed to describe inclusive diffraction

# Forward Jets

Long HERA program to understand parton cascade emissions by direct observation of jet pattern in the forward direction.  
... DGLAP v BFKL v CCFM v resolved  $\gamma^*$  ...

Conclusions limited by kinematic restriction to high  $x$  ( $> \sim 2 \cdot 10^{-3}$ ) and detector acceptance.

At LHeC ... more emissions due to longer ladder & more instrumentation  $\rightarrow$  measure at lower  $x$  where predictions really diverge.

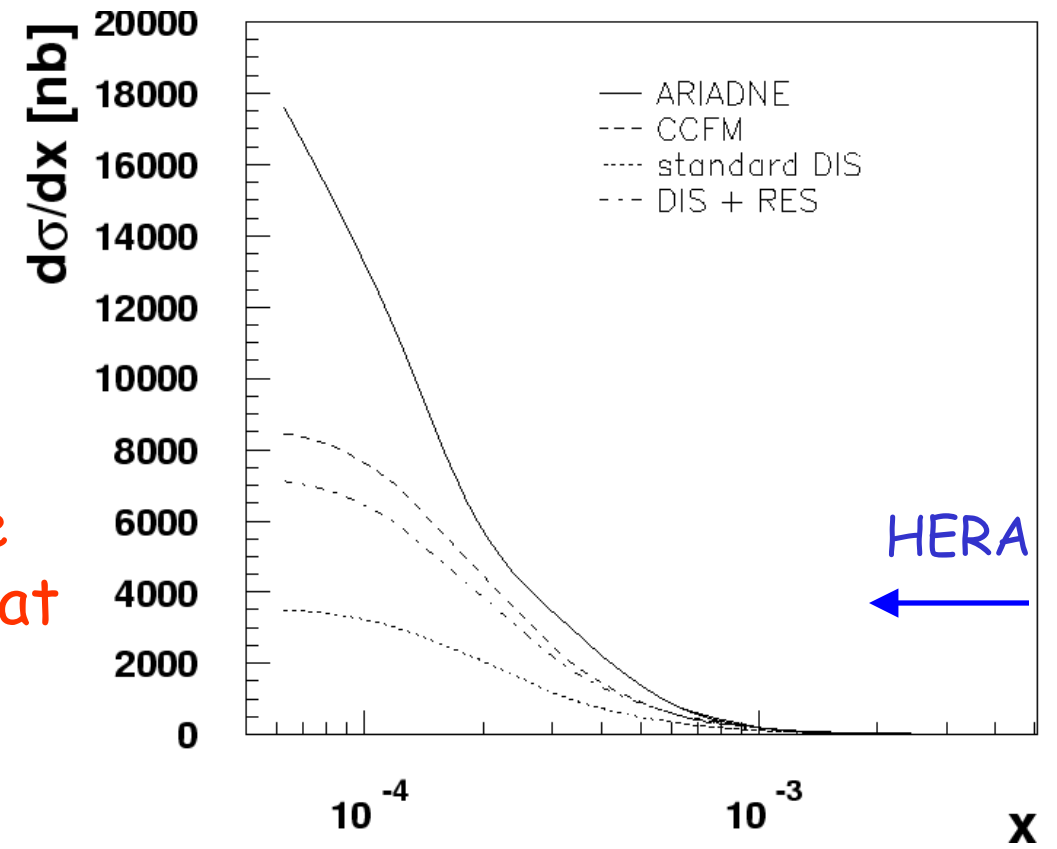
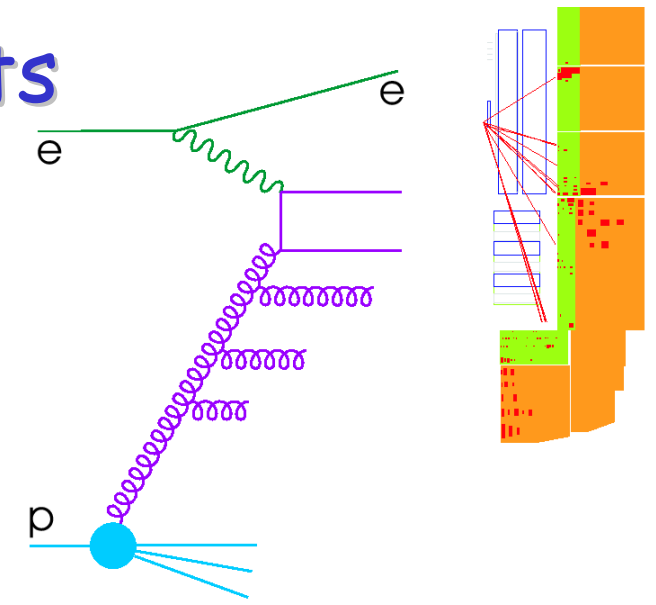

# Beyond Inclusive Measurements

- **Hadronic Final States:**
  - Jets, heavy flavours  
→ complementary pdf info, gluon directly, how to treat HF in QCD
  - ? Usefulness of HERA data often limited by scale uncties in theory

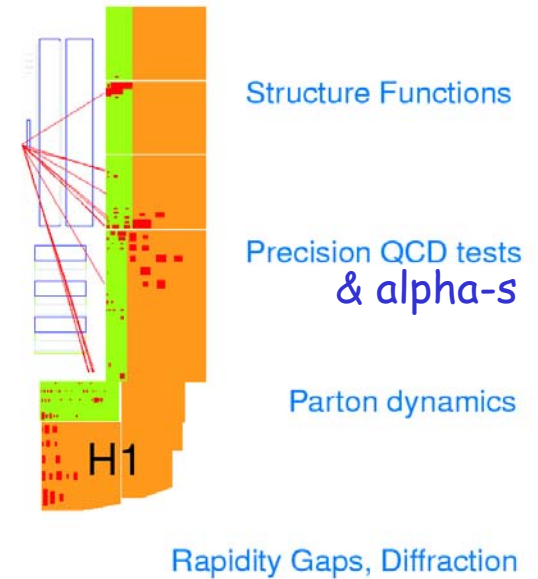
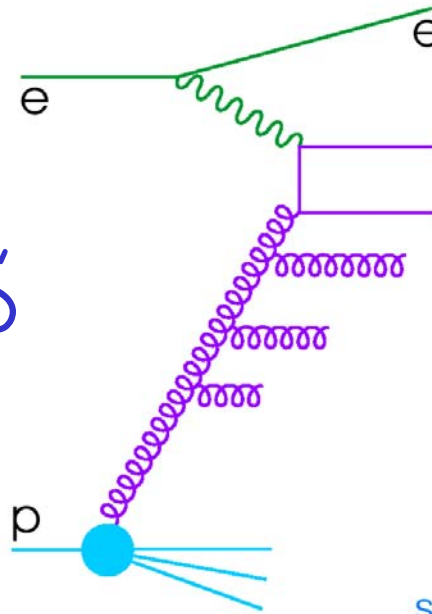

- **Forward Jets,**
  - Direct tests of assumed parton evolution patterns
  - ? Understanding limited by instrumentation near beam-pipe
- **Diffraction**
  - Unique clean probe of gap dynamics and elastic scattering
  - ? Understanding limited by (forward) detectors ...

# Motivation for TeV Scale DIS

- New Physics of eq Bound States,  $\nu^*$ , Selectrons ...  
leptoquarks, RP violating SUSY, quark compositeness
  - The Low  $x$  Limit of Quantum Chromodynamics  
high parton densities with low coupling  
` saturating; the parton growth, new evolution dynamics  
diffraction and confinement  
quark-gluon dynamics and the origin of mass
  - Precision Proton Structure for the LHC and elsewhere  
essential to know the initial state precisely (b, g ...)
  - Nuclear Parton Densities  
eA with AA  $\rightarrow$  partons in nuclei, Quark Gluon Plasma
- ... some considerations follow with  $E_e = 70 \text{ GeV}$ ,  $E_p = 7 \text{ TeV}$ ,  
lumi  $\sim 10^{33} \text{ cm}^{-2} \text{ s}^{-1}$  ( $\sim 10 \text{ fb}^{-1} \text{ year}^{-1}$ )...

# Azimuthal (de)correlations between Jets

[Jung]

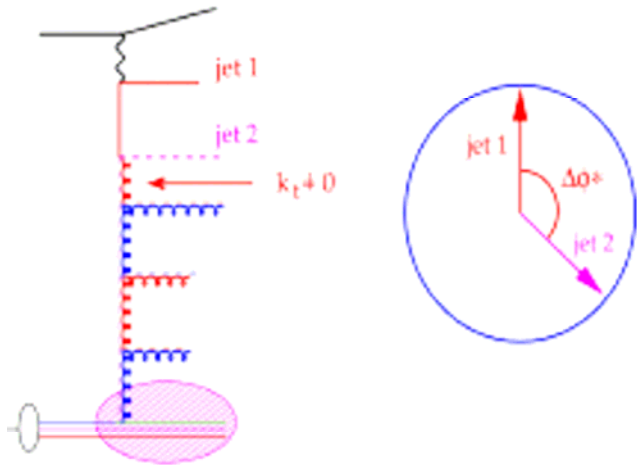

- $5 < Q^2 < 100 \text{ GeV}^2$   
 $-1 < \eta < 2.5$   
 $E_T > 5 \text{ GeV}$
- small  $k_t \rightarrow \Delta\phi \sim 180$
- large  $k_t$  from evolution

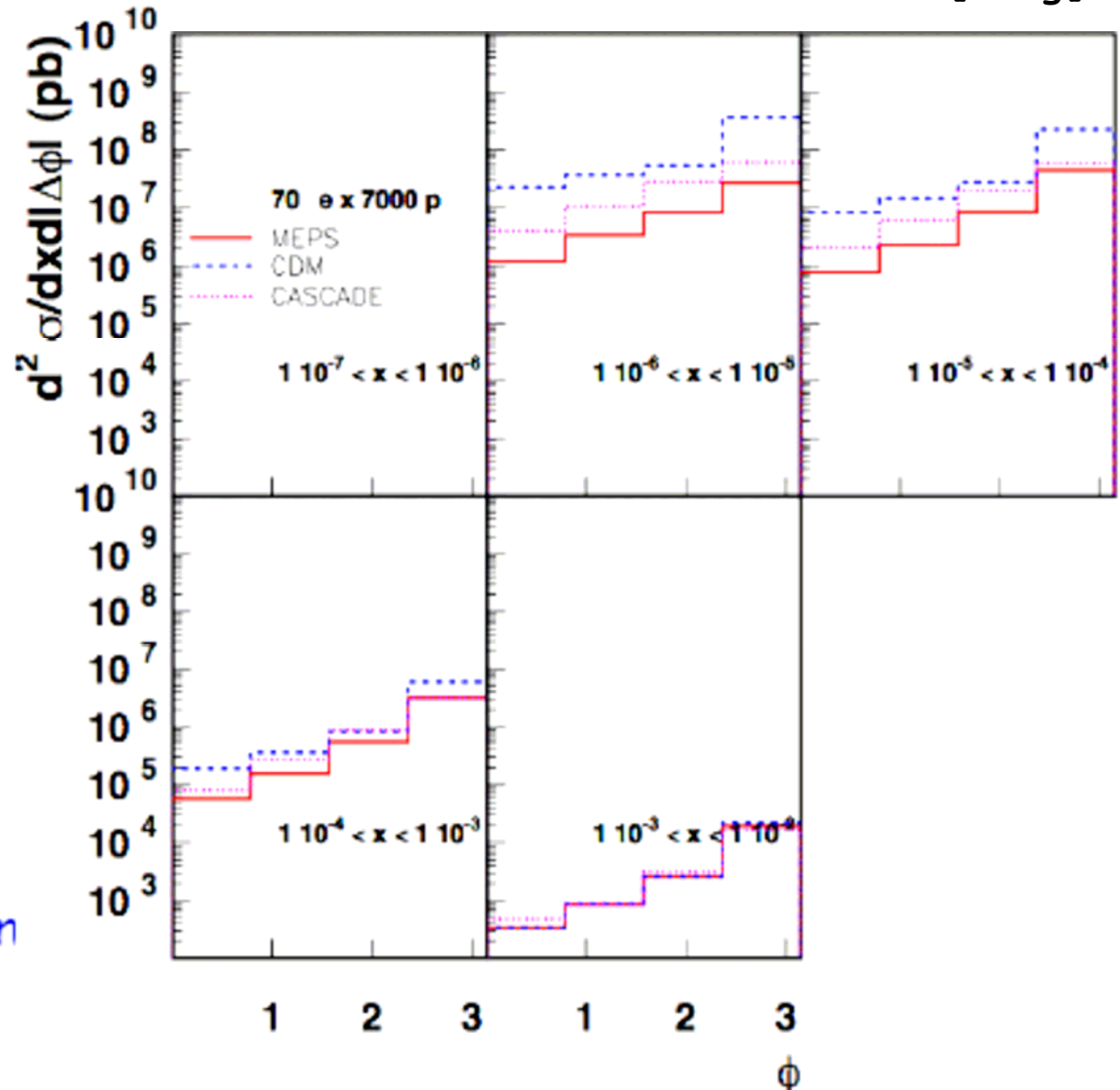



# Some topics from Interaction Region Group

[Burkhard]

## Interaction Region Design: ring ring option detailed presentations about ...

- \* *e-optics*: design of a low beta insertion, embedded into a LEP-2 like arc structure (Alexander Kling, B.H.)
- \* *e-geometry*: bypass regions, (Helmut Burkhardt)
- \* *p-optics*: low beta insertion combined with the LHC luminosity lattice (B.H.)
- \* *sc. IR magnets*: first exotic (?) ideas about (Stephan Russenschuck)
- \* *sc. double magnet design, active magnets* (Eugenio Paolomi, Simona Bettoni, Tim Greenshaw, )
- \* *synchrotron radiation*: and beam separation (Boris Nagorny)
- \* *rf cavities & power consumption* (John Jowett, Trevor Linnecar)

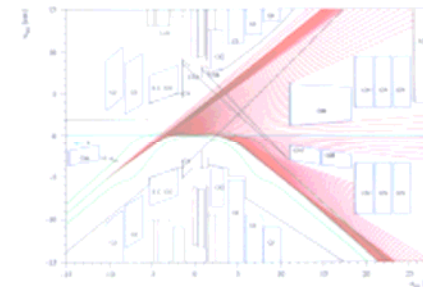
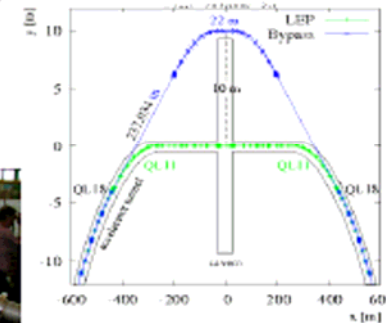
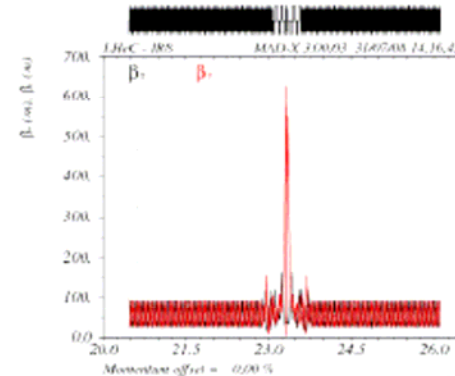

# Detector Group

## Agenda

### DETECTOR SESSION Tuesday morning

9:00h	PK,AP,RW	Introduction
9:15h	Norbert Wermes	Silicon Pixel Detectors for Tracking
10:00h	Michael Moll	RD50 and silicon hardness
10:30h		-coffee-
11:00h	Wesley Smith	Present and Future Collider Triggers
11:30h	Alex Cerri	Trigger and online displaced vertexing (CDF SVT)
12:00h	Andris Skuja	CMS Hadron Calorimeter
12:30h		-lunch-

### COMMON SESSION DET/ACC/IR Tuesday afternoon

14:00h	Tim Greenshaw	Instrumented Magnets
14:30h	Herman ten Kate	Magnet options for LHeC detector

### DETECTOR SESSION Tuesday afternoon

17:00h	Els Koffeman	Gossip gaseous pixel R&D
17:30h	Frank Simon	Calice calorimeters for the ILC
18:00h		 <b>Open Discussion</b>

... lots of discussion of optimum detector technologies etc

# A First Draft Detector?

## Detector (1st draft):

- Barrel Solenoid Magnet:
- Barrel Liquid Argon Calorimeter
- Central-Forward-Backward TRT Gossip “particle ID” & tracking
- Central Forward-Backward Tracker
- Innermost layer of high Res Pixel (Monolithic CMOS)
- Forward Backward CALICE Type Calorimeters
- Instrumented low beta magnets

Still the issue of acceptance v luminosity optimisation remains ...

→ 2 interaction points / experiments?

→ 2 phases of experiment (a la HERA)?

→ New idea: can we instrument the

(superconducting) focusing quadrupoles so they provide calorimetry as well as focusing (and add some Si in front?)